

# OWNER'S MANUAL

# SYLVANIA

## COLOR TV/VCR/DVD TRIPLE COMBO 6720FDE (20 inch)

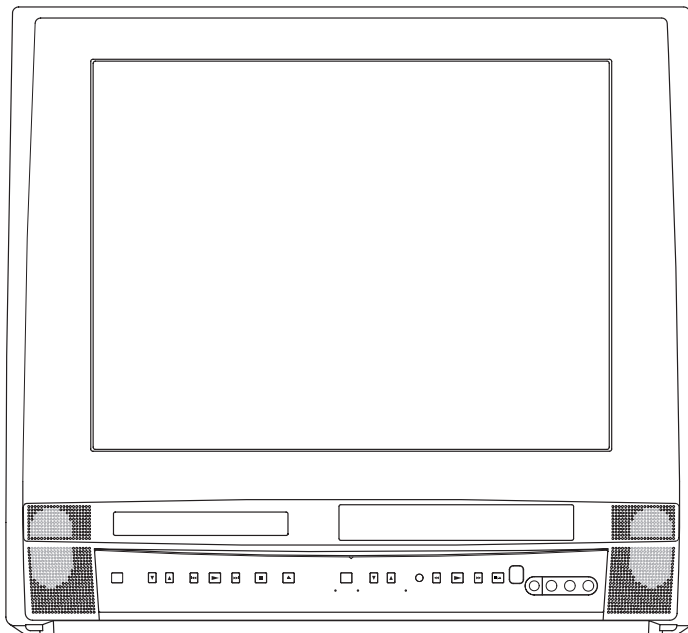

**This Owner's Manual is  
made of recycled paper.**

**INSTRUCCIONES EN ESPAÑOL INCLUIDAS.**

 As an ENERGY STAR® Partner, our company has determined that this product meets the ENERGY STAR® guidelines for energy efficiency. ENERGY STAR® is a U.S. registered mark.

**VHS**

### *SUPPLIED ACCESSORIES*

ACCESSORIES	PART NO.
Remote Control Unit	NE222UD
Batteries	2 AA Batteries
Owner's Manual	0EMN02469

If you need additional operating assistance after reading this owner's manual or to order replacement accessories, please call **TOLL FREE : 1-800-968-3429.**  
Or visit our **WEB SITE** at <http://www.funai-corp.com>

Please read before using this equipment

**WARNING:** TO REDUCE THE RISK OF FIRE OR ELECTRIC SHOCK, DO NOT EXPOSE THIS APPLIANCE TO RAIN OR MOISTURE.



**CAUTION**  
**RISK OF ELECTRIC SHOCK**  
**DO NOT OPEN**



**CAUTION:** TO REDUCE THE RISK OF ELECTRIC SHOCK, DO NOT REMOVE COVER (OR BACK). NO USER SERVICEABLE PARTS INSIDE. REFER SERVICING TO QUALIFIED SERVICE PERSONNEL.



THIS SYMBOL INDICATES THAT DANGEROUS VOLTAGE CONSTITUTING A RISK OF ELECTRIC SHOCK IS PRESENT WITHIN THIS UNIT.



THIS SYMBOL INDICATES THAT THERE ARE IMPORTANT OPERATING AND MAINTENANCE INSTRUCTIONS IN THE LITERATURE ACCOMPANYING THE APPLIANCE.

The caution marking is located on the rear of the cabinet.

## IMPORTANT SAFEGUARDS

- 1. Read instructions-**All the safety and operating instructions should be read before the appliance is operated.
- 2. Retain Instructions-**The safety and operating instructions should be retained for future reference.
- 3. Heed Warnings-**All warnings on the appliance and in the operating instructions should be adhered to.
- 4. Follow Instructions-**All operating and use instructions should be followed.
- 5. Cleaning-**Unplug TV/VCR/DVD from the wall outlet before cleaning. Do not use liquid cleaners or aerosol cleaners. Use a damp cloth for cleaning.  
**EXCEPTION:** A product that is meant for uninterrupted service and, that for some specific reason, such as the possibility of the loss of an authorization code for a CATV converter, is not intended to be unplugged by the user for cleaning or any other purpose, may exclude the reference to unplugging the appliance in the cleaning description otherwise required in item 5.
- 6. Attachments-**Do not use attachments not recommended by the TV/VCR/DVD manufacturer as they may cause hazards.
- 7. Water and Moisture-**Do not use this TV/VCR/DVD near water-for example, near a bath tub, wash bowl, kitchen sink, or laundry tub, in a wet basement, or near a swimming pool, and the like.
- 8. Accessories-**Do not place this TV/VCR/DVD on an unstable cart, stand, tripod, bracket, or table. The TV/VCR/DVD may fall, causing serious injury to someone, and serious damage to the appliance. Use only with a cart, stand, tripod, bracket, or table recommended by the manufacturer, or sold with the TV/VCR/DVD. Any mounting of the appliance should follow the manufacturer's instructions and should use a mounting accessory recommended by the manufacturer. An appliance and cart combination should be moved with care. Quick stops, excessive force, and uneven surfaces may cause the appliance and cart combination to overturn.

PORTABLE CART WARNING



**AMEUBLES-** Cet appareil ne doit être placé que sur un meuble (avec ou sans roulettes) recommandé par le fabricant. Si vous l'installez sur un meuble à roulettes, déplacez les deux ensembles avec précaution. Un arrêt brusque, l'utilisation d'une force excessive et des surfaces irrégulières risquent de déstabiliser l'ensemble et de le renverser.

SYMBÔLE D'AVERTISSEMENT POUR LES COMPOSANTES APPAREIL ET MEUBLE À ROULETTES



- 9. Ventilation-**Slots and openings in the cabinet and the back or bottom are provided for ventilation and to ensure reliable operation of the TV/VCR/DVD and to protect it from overheating, and these openings must not be blocked or covered. The openings should never be blocked by placing the TV/VCR/DVD on a bed, sofa, rug, or other similar surface. This TV/VCR/DVD should never be placed near or over a radiator or heat register. This TV/VCR/DVD should not be placed in a built-in installation such as a bookcase or rack unless proper ventilation is provided or the manufacturer's instructions have been adhered to.
- 10. Power Sources-**This TV/VCR/DVD should be operated only from the type of power source indicated on the marking label. If you are not sure of the type of power supply to your home, consult your appliance dealer or local power company. For TV/VCR/DVDs intended to operate from battery power, or other sources, refer to the operating instructions.
- 11. Grounding or Polarization-**This TV/VCR/DVD is equipped with a polarized alternating-current line plug (a plug having one blade wider than the other). This plug will fit into the power outlet only one way. This is a safety feature. If you are unable to insert the plug fully into the outlet, try reversing the plug. If the plug should still fail to fit, contact your electrician to replace your obsolete outlet. Do not defeat the safety purpose of the polarized plug.
- 12. Power-Cord Protection-**Power-supply cords should be routed so that they are not likely to be walked on or pinched by items placed upon or against them, paying particular attention to cords at plugs, convenience receptacles, and the point where they exit from the appliance.

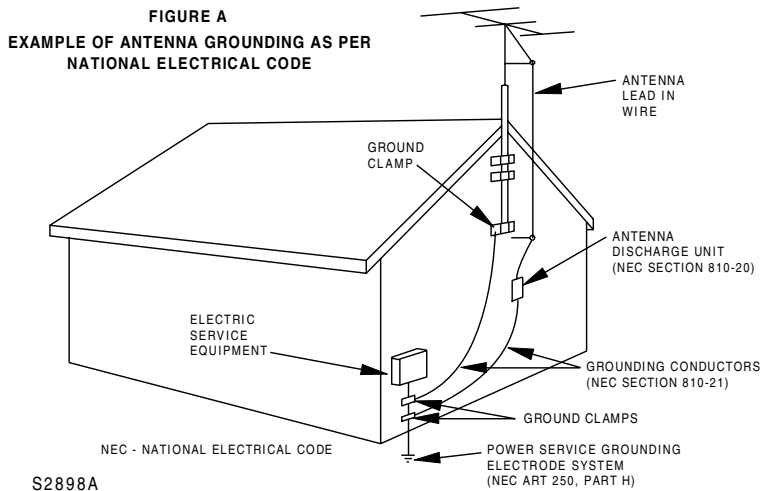

**13. Outdoor Antenna grounding-**If an outside antenna or cable system is connected to the TV/VCR/DVD, be sure the antenna or cable system is grounded so as to provide some protection against voltage surges and built-up static charges. Article 810 of the National Electrical Code, ANSI/NFPA No. 70, provides information with respect to proper grounding of the mast and supporting structure, grounding of the lead-in wire to an antenna discharge unit, size of grounding conductors, location of antenna-discharge unit, connection to grounding electrodes, and requirements for the grounding electrode. (Fig. A)

**14. Lightning-**For added protection for this TV/VCR/DVD receiver during a lightning storm, or when it is left unattended and unused for long periods of time, unplug it from the wall outlet and disconnect the antenna or cable system. This will prevent damage to the TV/VCR/DVD due to lightning and power-line surges.

**15. Power Lines-**An outside antenna system should not be located in the vicinity of overhead power lines or other electric light or power circuits, or where it can fall into such power lines or circuits. When installing an outside antenna system, extreme care should be taken to keep from touching such power lines or circuits as contact with them might be fatal.

**16. Overloading-**Do not overload wall outlets and extension cords as this can result in a risk of fire or electric shock.

**17. Object and Liquid Entry-**Never push objects of any kind into this TV/VCR/DVD through openings as they may touch dangerous voltage points or short out parts that could result in a fire or electric shock. Never spill liquid of any kind on the TV/VCR/DVD.

**18. Servicing-**Do not attempt to service this TV/VCR/DVD yourself as opening or removing covers may expose you to dangerous voltage or other hazards. Refer all servicing to qualified service personnel.

**19. Damage Requiring Service-**Unplug this TV/VCR/DVD from the wall outlet and refer servicing to qualified service personnel under the following conditions:

- a. When the power-supply cord or plug is damaged or frayed.
- b. If liquid has been spilled, or objects have fallen into the TV/VCR/DVD.
- c. If the TV/VCR/DVD has been exposed to rain or water.
- d. If the TV/VCR/DVD does not operate normally by following the operating instructions. Adjust only those controls that are covered by the operating instructions, as improper adjustment of other controls may result in damage and will often require extensive work by a qualified technician to restore the TV/VCR/DVD to its normal operation.
- e. If the TV/VCR/DVD has been dropped or damaged in any way.
- f. When the TV/VCR/DVD exhibits a distinct change in performance-this indicates a need for service.

**20. Replacement Parts-**When replacement parts are required, be sure the service technician has used replacement parts specified by the manufacturer that have the same characteristics as the original part. Unauthorized substitutions may result in fire, electric shock, injury to persons or other hazards.

**21. Safety Check-**Upon completion of any service or repairs to this TV/VCR/DVD, ask the service technician to perform routine safety checks to determine that the TV/VCR/DVD is in proper operating condition.

**22. Heat-**This TV/VCR/DVD product should be situated away from heat sources such as radiators, heat registers, stoves, or other products (including amplifiers) that produce heat.

**CAUTION: TO PREVENT ELECTRIC SHOCK, MATCH WIDE BLADE OF PLUG TO WIDE SLOT, FULLY INSERT.**

**ATTENTION: POUR ÉVITER LES CHOC ÉLECTRIQUES, INTRODUIRE LA LAME LA PLUS LARGE DE LA FICHE DANS LA BORNE CORRESPONDANTE DE LA PRISE ET POUSSER JUSQU'AU FOND.**

# PRECAUTIONS

## IMPORTANT COPYRIGHT INFORMATION

Unauthorized copying, broadcasting, public performance and lending of discs are prohibited.

**FCC WARNING-** This equipment may generate or use radio frequency energy. Changes or modifications to this equipment may cause harmful interference unless the modifications are expressly approved in the instruction manual. The user could lose the authority to operate this equipment if an unauthorized change or modification is made.

## RADIO-TV INTERFERENCE

This equipment has been tested and found to comply with the limits for a Class B digital device, pursuant to Part 15 of the FCC Rules. These limits are designed to provide reasonable protection against harmful interference in a residential installation. This equipment generates, uses, and can radiate radio frequency energy and, if not installed and used in accordance with the instructions, may cause harmful interference to radio communications.

However, there is no guarantee that interference will not occur in a particular installation. If this equipment does cause harmful interference to radio or television reception, which can be determined by turning the equipment off and on, the user is encouraged to try to correct the interference by one or more of the following measures:

- 1) Reorient or relocate the receiving antenna.
- 2) Increase the separation between the equipment and receiver.
- 3) Connect the equipment into an outlet on a circuit different from that to which the receiver is connected.
- 4) Consult the dealer or an experienced radio/TV technician for help.

## LASER SAFETY

This unit employs a laser. Only a qualified service person should remove the cover or attempt to service this device, due to possible eye injury.

**CAUTION:** USE OF CONTROLS OR ADJUSTMENTS OR PERFORMANCE OF PROCEDURES OTHER THAN THOSE SPECIFIED HEREIN MAY RESULT IN HAZARDOUS RADIATION EXPOSURE.

**CAUTION:** VISIBLE AND INVISIBLE LASER RADIATION WHEN OPEN AND INTERLOCK DEFEATED. DO NOT STARE INTO BEAM.

**LOCATION:** INSIDE, NEAR THE DECK MECHANISM.

**This Class B digital apparatus complies with Canadian ICES-003.**

**Cet appareil numérique de la classe B est conforme à la norme NMB-003 du Canada.**

**CAUTION:** TO PREVENT ELECTRIC SHOCK, MATCH WIDE BLADE OF PLUG TO WIDE SLOT, FULLY INSERT.

**ATTENTION:** POUR ÉVITER LES CHOCS ÉLECTRIQUES, INTRODUIRE LA LAME LA PLUS LARGE DE LA FICHE DANS LA BORNE CORRESPONDANTE DE LA PRISE ET POUSSER JUSQU'AU FOND.

## LOCATION

For safe operation and satisfactory performance of your TV/VCR/DVD, keep the following in mind when selecting a place for its installation:

- Shield it from direct sunlight and keep it away from sources of intense heat.
- Avoid dusty or humid places.
- Avoid places with insufficient ventilation for proper heat dissipation. Do not block the ventilation holes at the top and bottom of the unit. Do not place the unit on a carpet because this will block the ventilation holes.
- Install unit in a horizontal position.
- Avoid locations subject to strong vibration.
- Do not place the TV/VCR/DVD near strong magnetic fields.
- Avoid moving TV/VCR/DVD to locations where temperature differences are extreme.

## AVOID THE HAZARDS OF ELECTRICAL SHOCK AND FIRE

- Do not handle the power cord with wet hands.
- Do not pull on the power cord when disconnecting it from an AC wall outlet. Grasp it by the plug.
- If, by accident, water is spilled on your unit, unplug the power cord immediately and take the unit to our Authorized Service Center for servicing.
- Do not put your fingers or objects into the TV/VCR/DVD disc loading tray.
- Do not place anything directly on top of the unit.

## WARNING

Moisture condensation may occur inside the unit when it is moved from a cold place to a warm place, or after heating a cold room or under conditions of high humidity. If a DVD is played in a TV/DVD/VCR which has moisture, it may damage the DVD and TV/VCR/DVD. Therefore when the condensation occurs inside the unit, turn the POWER on and allow at least 2 hours for the unit to dry out.

## SYMBOLS USED IN THIS MANUAL

The following symbols below appear in some headings and notes in this manual, with the following meanings

### TV/VCR

: Description refers to TV/VCR operation (in the TV/VCR mode).

### DVD-V

: Description refers to playback of DVD video discs (in the DVD mode).

### CD

: Description refers to playback of audio CDs (in the DVD mode).

### MP3

: Description refers to playback of MP3 discs (in the DVD mode).

### QUICK

: Description refers to the items to be set by the QUICK mode (in the DVD mode).

### A NOTE ABOUT RECYCLING

This product's packaging materials are recyclable and can be reused. Please dispose of any materials in accordance with your local recycling regulations.

Batteries should never be thrown away or incinerated but disposed of in accordance with your local regulations concerning chemical wastes.

The serial number of this product may be found on the back of the unit. No other TV/VCR/DVD has the same serial number as yours. You should record the number and other vital information here and retain this book as a permanent record of your purchase to aid identification in case of theft. Serial numbers are not kept on file.

Date of Purchase	
Dealer Purchase from	
Dealer Address	
Dealer Phone No.	
Model No.	
Serial No.	

# TABLE OF CONTENTS

■ <b>IMPORTANT SAFEGUARDS</b> . . .2, 3	PICTURE SEARCH . . . . .26	TITLE / CHAPTER SEARCH . . .39
■ <b>PRECAUTIONS</b> . . . . .4	STILL PICTURE . . . . .26	TIME SEARCH . . . . .39
LOCATION . . . . .5	VERTICAL HOLD CONTROL . . .26	MARKER SETUP SCREEN . . . .39
AVOID THE HAZARDS OF ELECTRICAL SHOCK AND FIRE . .5	■ <b>SPECIAL PLAYBACK</b> . . . . .27	■ <b>SPECIAL PLAYBACK FUNCTION</b> . .40
WARNING . . . . .5	RENTAL PLAYBACK . . . . .27	REPEAT . . . . .40
SYMBOLS USED IN THIS MANUAL . . . . .5	AUTO REPEAT PLAYBACK . . .27	PROGRAM . . . . .40
■ <b>TABLE OF CONTENTS</b> . . . . .6	■ <b>SEARCH</b> . . . . .28	RANDOM PLAYBACK . . . . .40
■ <b>FEATURES</b> . . . . .7	ZERO RETURN . . . . .28	■ <b>PLAYING A MP3 DISC</b> . . . . .41
■ <b>OPERATING CONTROLS AND FUNCTIONS</b> . . . . .9, 10	TIME SEARCH . . . . .28	MP3 PLAYBACK . . . . .41
■ <b>PREPARATION FOR USE</b> . . . . .11	INDEX SEARCH . . . . .29	TRACK SELECTION . . . . .41
ANTENNA/CABLE CONNECTION . . . . .11	■ <b>SPECIAL FEATURES</b> . . . . .29	PROGRAM . . . . .41
CONNECTING TO EXTERNAL INPUT JACKS . . . . .12	REAL TIME TAPE COUNTER . . .29	RANDOM PLAYBACK . . . . .41
INSTALLING THE BATTERIES . .12	AUTO REWIND-EJECT . . . . .29	■ <b>CHANGING THE SETTINGS</b> . . .42
EXTERNAL INPUT MODE . . . . .12	■ <b>RECORDING</b> . . . . .30	SUBTITLE LANGUAGE . . . . .42
CONNECTING TO A STEREO AMPLIFIER EQUIPPED WITH DIGI- TAL INPUT JACKS SUCH AS MD DECK OR DAT DECK (for DVD) .13	NORMAL RECORDING . . . . .30	AUDIO LANGUAGE . . . . .42
CONNECTING TO A DOLBY DIGITAL DECODER (for DVD) . .14	SKIPPING UNWANTED SCENES DURING RECORDING . . . . .30	STEREO SOUND MODE . . . . .42
<b>TV/VCR SECTION</b>	OTR (One Touch Recording) . . .31	CAMERA ANGLE . . . . .42
■ <b>SET UP FOR USE</b> . . . . .15	COPYING A VIDEO CASSETTE (Requires a VCR or camcorder) . .31	BLACK LEVEL SETTING . . . . .42
SELECTING THE LANGUAGE . .15	■ <b>TIMER</b> . . . . .32	VIRTUAL SURROUND . . . . .42
CLOCK SET UP (AUTO / MANUAL) . . . . .15, 16	AUTOMATIC TIMER RECORDING . . . . .32	■ <b>THE ON-SCREEN INFORMATION</b> . .43
DAYLIGHT-SAVING TIME . . . . .17	TIMER PROGRAM EXTENSION .33	■ <b>CHANGING THE DVD SETUP ITEMS</b> . . . . .44
CHANNEL SET UP . . . . .18	HINTS FOR AUTOMATIC TIMER RECORDING . . . . .34	LANGUAGE SETTING . . . . .44
DELETING (OR ADDING) CHANNEL . . . . .18	AUTO RETURN . . . . .34	DISPLAY SETTING . . . . .45
■ <b>TV OPERATION</b> . . . . .19	SLEEP TIMER . . . . .34	AUDIO SETTINGS . . . . .45
WATCHING A TV PROGRAM . .19	■ <b>ON SCREEN DISPLAY</b> . . . . .35	PARENTAL CONTROL . . . . .46
DEGAUSSING . . . . .19	■ <b>CABLE CHANNEL DESIGNATIONS</b> . . . . .35	■ <b>TROUBLESHOOTING GUIDE</b> . .47
PICTURE CONTROL . . . . .19	<b>DVD SECTION</b>	■ <b>MAINTENANCE</b> . . . . .50
CLOSED CAPTION SYSTEM . . .20	■ <b>ABOUT THE DISCS</b> . . . . .36	DISC HANDLING . . . . .50
V-CHIP SET UP . . . . .21	PLAYABLE DISCS . . . . .36	■ <b>SPECIFICATIONS</b> . . . . .51
■ <b>MTS(Multi-Channel Television sound)SYSTEM</b> . . . . .23	DISC TYPES . . . . .36	■ <b>WARRANTY</b> . . . . .Back Cover
CHECKING THE SELECTED MTS MODE . . . . .23	■ <b>PLAYING A DISC</b> . . . . .37	
MTS RECORDING/MONITOR MODE . . . . .23	BASIC PLAYBACK . . . . .37	
SELECTING THE MTS SYSTEM .24	GENERAL FEATURES . . . . .37	
■ <b>VIDEO CASSETTE</b> . . . . .25	DISC MENU . . . . .37	
■ <b>PLAYBACK</b> . . . . .26	TITLE MENU . . . . .37	
NORMAL PLAYBACK . . . . .26	RESUME . . . . .38	
TRACKING ADJUSTMENT . . . .26	PAUSE . . . . .38	
SLOW MOTION . . . . .26	STEP BY STEP PLAYBACK . . . .38	
	FAST FORWARD/REVERSE SEARCH . . . . .38	
	SLOW FORWARD / SLOW REVERSE . . . . .38	
	■ <b>SEARCH FUNCTION</b> . . . . .39	
	TRACK SEARCH . . . . .39	



# FEATURES

## TV/VCR Mode

- **Hi-Fi system**—The Hi-Fi stereo recording system offers you excellent sound quality with a dynamic range of 80dB, frequency response from 20Hz to 20kHz, and 0.005% wow and flutter.
- **Rotary 4-head Record/Playback System**—Four heads ensure excellent picture quality and special effects playback.
- **Index Search**—Fast-forwards to start of next recording.
- **Slow Motion**—View recorded program at slower than normal speed.
- **Infrared remote control**
- **Trilingual on screen TV/VCR setup display selectable in English or Spanish or French**
- **Real time counter**—This shows the elapsed recording or playback time in hours, minutes, and seconds. The “-” indication will appear when the tape is rewound further than the tape counter position “0:00:00”.
- **181 channel capability PLL frequency synthesizer tuner with direct station call**—(A converter may be necessary to view scrambled cable channels.)
- **Auto Clock Setting**—Allows you to set the clock function from a PBS broadcast station.
- **Closed caption system**—You may view specially labeled (cc) TV programs, movies, news, prerecorded tapes, etc. with either a dialogue caption or text display added to the program.
- **Auto power on and off system**—Automatically turns on the TV/VCR/DVD when you insert the cassette, turns off after auto-rewind, and ejects when the beginning of the tape is reached.
- **Auto rewind when the end of a tape is reached**—This function doesn’t occur when using timer recording.
- **Smooth mode change**—TV/VCR mode, DVD mode automatically changes without control.
- **2 Step picture search operation**—You can view a video program at a high speed or super high speed in either a forward or reverse direction in LP and SLP mode. For SP mode only high speed.
- **Three different playback tape speeds : SP/LP/SLP**
- **Two different recording tape speeds : SP/SLP**
- **Auto Head Cleaner**—Automatically cleans video heads as you insert or remove a cassette.
- **Zero Return**—The tape returns to counter of 0:00:00 by rewinding or fast forwarding.
- **Still**—“Freeze” the picture at any time, for close viewing of a particular scene.
- **Digital Auto Tracking (DTR)**—Automatically adjusts the tracking for each tape you play.
- **Rental play mode**—Improves playback picture quality from worn tapes, such as rental tapes.
- **Auto repeat**—Allows you to repeat the playing of a tape indefinitely without pressing the PLAY button.
- **Time search**—Let you set the TV/VCR/DVD to advance the tape by entering the desired playback time you want to skip.
- **OTR (One Touch Recording)**—Instant timed recording from 30 to 480 minutes is possible at the push of the REC/OTR button.
- **1 Year, 8 events (including Daily and Weekly Timer Recording)**—The built-in timer allows you to record up to 8 programs at different times on different channels up to 1 year in advance. The Daily timer allows recordings to be made of daily broadcasts, and the Weekly timer allows recording to be made once a week up to the end of the tape.
- **Auto return**—After timer recording is finished, the TV/VCR/DVD can return to the beginning of the recording.
- **Sleep timer**—Allows you to have the TV/VCR/DVD automatically turn off at a desired time.  
**Timer Program Extension**—Allow you to shift the time schedule for automatic timer recording.
- **V-CHIP**—Enables parents to prevent their children from watching inappropriate material on TV.

### A NOTE ABOUT RECYCLING

This product’s packaging materials are recyclable and can be reused. Please dispose of any materials in accordance with your local recycling regulations.

Batteries should never be thrown away or incinerated but disposed of in accordance with your local regulations concerning chemical wastes.

## DVD Mode

- **Dolby Digital sound**  
This TV/VCR/DVD can handle Dolby Digital surround sound having 5.1 channels when connected to a Dolby Digital decoder.
- **Still/fast/slow/step playback**  
Various playback modes are available including still pictures, fast forward/reverse, slow motion and step frames.
- **Random playback for audio CD and MP3**  
This TV/VCR/DVD can shuffle the order of tracks to play them in random order.
- **Program playback for audio CD and MP3**  
You can program the order of tracks to play them in any desired order.
- **DVD menus in a desired language**  
You can display DVD menus in a desired language, if available on a DVD.
- **Screen saver/Auto power-off functions**  
The screen saver program starts when there is no input from the TV/VCR/DVD for five minutes in the stop mode. When the screen saver program is activated for 15 minutes, the power automatically turns off.
- **Subtitles in a desired language**  
You can select a desired language for the display subtitles, if that language is available on a disc.
- **Selecting a camera angle**  
You can select the desired camera angle, if a disc contains sequences recorded from different angles.
- **Choices for audio language and sound mode**  
You can select the desired audio language and sound mode, if different languages and modes are available on a disc.
- **Parental lock**  
You can set the control level to limit playback of discs which may not be suitable for children.
- **Automatic detection of discs**  
This TV/VCR/DVD automatically detects if the loaded disc is DVD, audio CD or MP3 on disc.
- **Playback MP3 disc**
- **On-screen display**  
Information about the current operation can be displayed on a TV screen, allowing you to confirm the currently active functions (such as program playback), on the TV screen using the remote control.
- **Search**  
Chapter search / Title search / Track search / Time search
- **Repeat**  
Chapter / Title / Track / Group / All / A-B
- **Marker**  
The part designated by user can be called back.
- **Resume Play**  
User can resume to playback from the part at which the play was stopped.
- **Virtual Surround**
- **Bit rate indication**
- **DRC (Dynamic range control)**  
You can control the range of sound volume.

### NOTE:

- We do not recommend the use of universal remote controls. Not all of the functions may be controlled with a universal remote control.  
If you decide to use a universal remote control with this TV/VCR/DVD, please be aware that the code number given may not operate this TV/VCR/DVD. In this case, please call the manufacturer of the universal remote control.



# OPERATING CONTROLS AND FUNCTIONS

## - TV/VCR/DVD FRONT PANEL - [Fig.1]

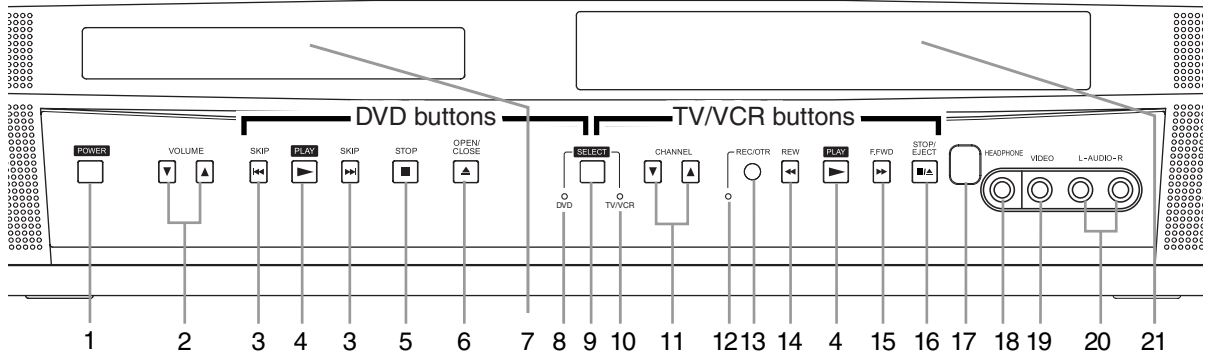

## - REMOTE CONTROL - [Fig. 2]

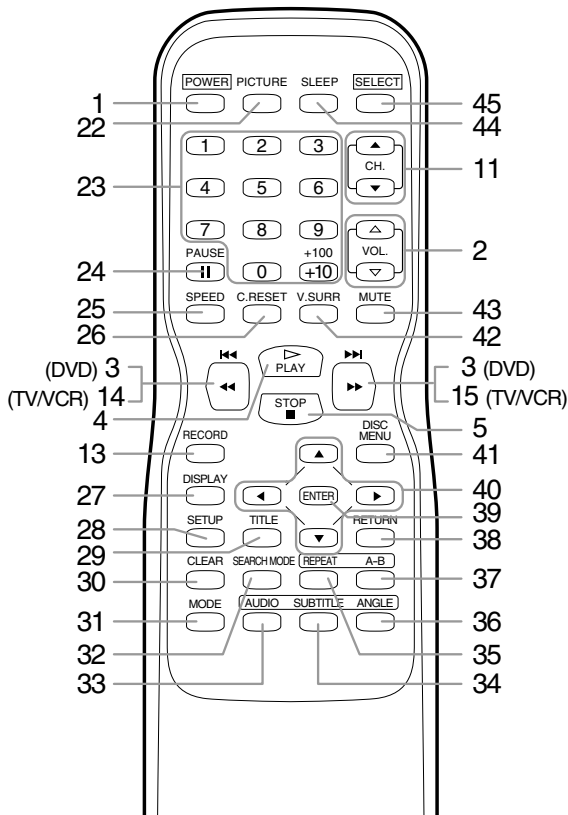

**1. POWER Button** [TV/VCR P.15 / DVD P.37]  
Press to turn the power on and off.

**2. VOLUME  $\Delta/\nabla$  Buttons**  
Press to control the volume level for the DVD and TV.

**3. SKIP Buttons (for DVD)**[P.38]  
Press once to skip chapters or tracks to a desired point.  
Press and hold to change forward or reverse playback speed.

**4. PLAY Button** [TV/VCR P.26 / DVD P.37]  
Starts playback of the disc or tape contents.

**5. STOP Button** [TV/VCR P.26 / DVD P.37]

Stops operation of the disc. (or front panel)  
Stops operation of the disc or tape contents. (remote control)

**6. OPEN/CLOSE Button** [DVD P.37]

Press to insert discs into or remove them from the tray.

**7. Disc loading tray**

**8. DVD Indicator**

Lights on during DVD mode.

**9. SELECT Button**

Press to change to TV/VCR mode, external input mode or DVD mode.

**10. TV/VCR Indicator**

Lights on during TV/VCR mode.

**11. CHANNEL  $\Delta/\nabla$  Buttons**

Press to select memorized channel.

**12. Recording Indicator**

Flashes during recording. Lights up in the Standby mode for Timer Recording.

**13. REC/OTR (RECORD)Button** [TV/VCR P.30, 31]

Press for manual recording. Activates One Touch Recording. (OTR is only during TV/VCR mode.)

**14. REW Button (for TV/VCR)** [TV/VCR P.26]

Press to rewind the tape, or to view the picture rapidly in reverse during playback mode. (Rewind Search)

**15. F.FWD Button (for TV/VCR)** [TV/VCR P.26]

Press to rapidly advance the tape, or to view the picture rapidly in forward during playback mode. (Forward Search)

**16. STOP/EJECT Button** [TV/VCR P.28]

Press to stop the tape motion. Press in the Stop mode to remove tape from the TV/VCR/DVD.

**17. Remote sensor window**

**18. HEADPHONE Jack**

To connect headphone (not supplied) for personal listening.

**19. VIDEO input Jack**

Connect to the video output jack of a video camera or VCR.

## - TV/VCR/DVD REAR PANEL - [Fig.3]

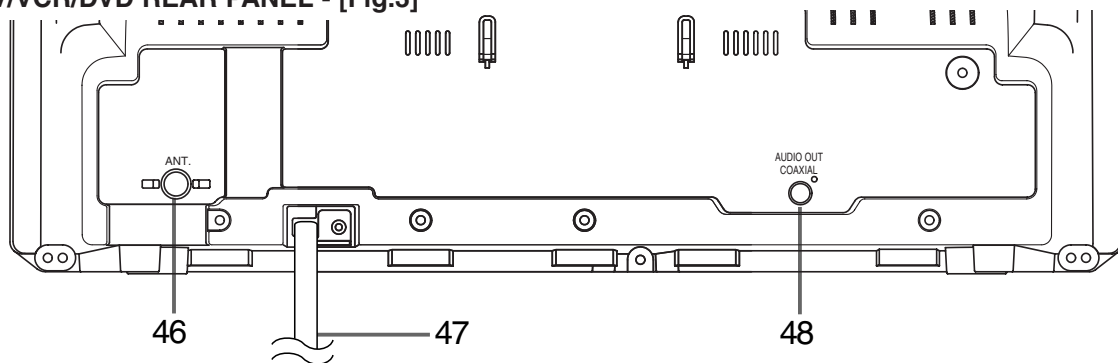

### 20. AUDIO L/R input Jacks

Connect to the audio output jacks of a video camera or VCR.

### 21. Cassette compartment

### 22. PICTURE Button

Press to adjust the picture.

### 23. Number Buttons

#### TV Mode:[P.15]

Press two digits to directly access the desired channel.

Remember to press a "0" before a single digit channel.

#### +100 Button-

Press to select cable channels which are equal or greater than number 100.

#### DVD Mode:

Press to enter the desired number.

#### +10 Button-

Press to enter the desired numbers which are equal or greater than number 10.

### 24. PAUSE Button [TV/VCR P.26 / DVD P.38]

Pauses the current disc or tape operation.

### 25. SPEED Button [TV/VCR P.30]

Press to choose the desired recording speed: SP/SLP.

### 26. C.RESET Button [TV/VCR P.28]

Press to reset counter to 0:00:00.

Press to cancel a setting of timer program. (See page 33.)

### 27. DISPLAY Button

#### TV/VCR Mode:

Display the counter or the current channel number and current time on the TV screen.

#### DVD Mode:[P.43]

Displays the current status on the TV screen for checking purposes.

### 28. SETUP Button [TV/VCR P.15] [DVD P.44-46]

Press to enter or exit the TV menu or DVD setup mode.

### 29. TITLE Button [DVD P.37]

Displays the title menu.

### 30. CLEAR Button

Resets a setting.

### 31. MODE Button [DVD P.41]

Activates program playback or random playback mode.

### 32. SEARCH MODE Button [DVD P.39]

Press to locate a desired point.

### 33. AUDIO Button [DVD P.42]

Press to select a desired audio language or sound mode.

### 34. SUBTITLE Button [DVD P.42]

Press to select a desired subtitle language.

### 35. REPEAT Button [DVD P.42]

Repeats playback of the current disc, title, chapter or track.

### 36. ANGLE Button (DVD mode) [DVD P.42]

Press to change the camera angle to see the sequence being played back from a different angle.

### 37. A-B REPEAT Button [DVD P.40]

Repeats playback of a selected section.

### 38. RETURN Button

Returns to the previous operation in the DVD setup mode.

### 39. ENTER Button

Press to accept a setting.

### 40. Arrow Buttons

#### TV/VCR Mode:

Press to select a setting mode from the menu on the TV screen.

Press to select or adjust from a particular menu.

#### DVD Mode:

Use when making settings while watching the display on a TV screen.

### 41. DISC MENU Button [DVD P.37]

Displays the menus in the DVD.

### 42. V. Surr (VIRTUAL SURROUND) Button [DVD P.42]

Sets virtual surround on/off.

### 43. MUTE Button

Mutes the sound. Press it again to resume sound.

### 44. SLEEP Button [TV/VCR P.34]

Sets the Sleep Timer.

### 45. SELECT Button

Press to switch TV/VCR and DVD mode. You can see the mode (TV/VCR or DVD) on the front panel indicator.

#### 46. ANT. in Jack

Connect to an antenna, cable system, or satellite system.

#### 47. Power cord

Connect to a standard AC outlet (120V/60Hz).

**NOTE:** Remove the power cord from the hook to avoid breaking a wire before you connect to a standard AC outlet.

#### 48. COAXIAL digital audio out Jack

Connect to the digital input of an external amplifier or decoder for DVD audio only.

## PREPARATION FOR USE

### ANTENNA/CABLE CONNECTION

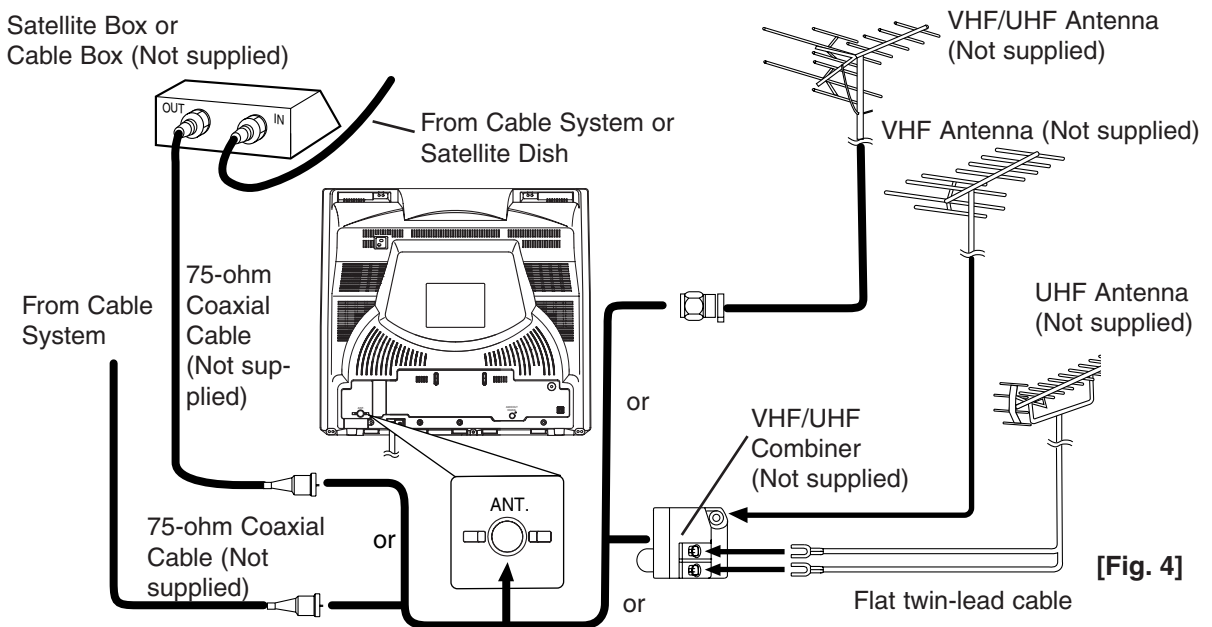

#### VHF/UHF SEPARATE ANTENNAS

In some areas it will be necessary to use an outdoor antenna.

#### CABLE WITHOUT CONVERTER/DESCRAMBLER BOX

Use this connection if your cable system connects directly to your TV/VCR/DVD without a converter box.

By using this connection you can:

- 1) Use the TV/VCR/DVD remote to select channels.
- 2) Program one or more unscrambled channels for Automatic Timer Recording.

**NOTE:** This TV/VCR/DVD will ONLY record and view the same channel.

#### CABLE WITH CONVERTER/DESCRAMBLER BOX OR SATELLITE BOX

If your cable service supplies you with a converter box or if you use a satellite system, you can use the basic connection shown in the illustration.

By using this connection you can also record scrambled channels. However, channel selection must be made with the converter box or satellite box. This means that channels cannot be changed using the TV/VCR/DVD Remote Control. Unattended timer recording is limited to one channel at a time.

**Antenna/Cable Connections  
Continued on the Next Page.**

## TO RECORD A SCRAMBLED/UNSCRAMBLED CHANNEL

1. Set the TV/VCR/DVD channel selector to the output channel of the Cable Converter Box or Satellite Box. (Ex. CH3)
2. Select the channel to record from your Cable Converter Box or Satellite Box.

### Note to CATV system installer:

This reminder is provided to call the CATV system installer's attention to Article 820-40 of the NEC that provides guidelines for proper grounding and, in particular, specifies that the cable ground shall be connected to the grounding system of the building as close to the point of cable entry as practical.

## CONNECTING TO EXTERNAL INPUT JACKS

When you watch a program recorded on another source (VCR or video camera), use the audio/video input jacks on the front of the TV/VCR/DVD.

Connect the audio/video output jacks of another source to the AUDIO L/R and VIDEO jacks of this TV/VCR/DVD.

Then press the CHANNEL button ▲ or ▼ until "AUX" appears on the screen.

### NOTE:

- When you connect a monaural VCR (another source) to this TV/VCR/DVD, connect the Audio output jack of the monaural VCR (another source) to the AUDIO L jack of this TV/VCR/DVD. The audio will output in both L and R channel equally.

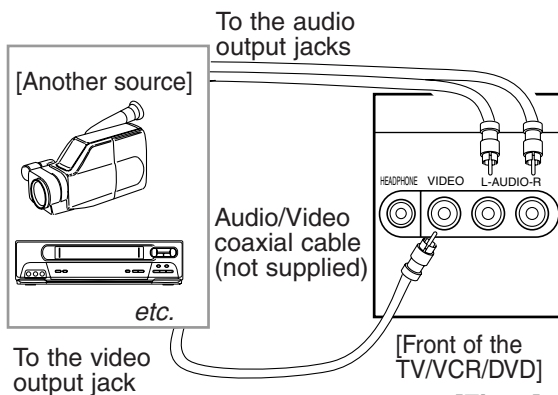

[Fig. 5]

## INSTALLING THE BATTERIES

- 1) Open the battery compartment cover by pressing the cover on the remote unit in the direction of the arrow.
- 2) Insert 2 "AA" penlight batteries into the battery compartment in the direction indicated by the polarity (+/-) markings.
- 3) Replace the cover.

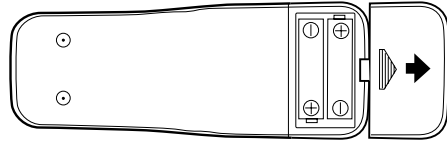

## EXTERNAL INPUT MODE

When using an external input signal (another VCR or video camera), connect the player's audio/video output cables to the AUDIO L/R IN/VIDEO IN jacks of your TV/VCR/DVD. Then press the CHANNEL button ▲ or ▼ until "AUX" appears on the screen.

AUX

## CONNECTING TO A STEREO AMPLIFIER EQUIPPED WITH DIGITAL INPUT JACKS SUCH AS MD DECK OR DAT DECK (for DVD)

Use an audio coaxial digital cable available at retail for the audio connections.

Connecting to an amplifier equipped with digital input jacks such as MD Deck or DAT Deck.

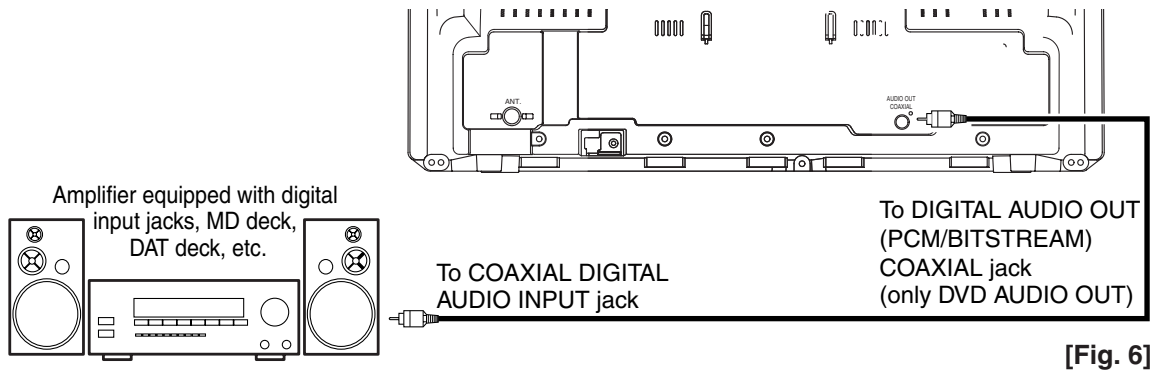

### NOTES:

- The audio source on a disc in a 5.1 channel Dolby Digital surround format cannot be recorded as digital sound by an MD or DAT deck.
- Be sure to turn off the power to all components in the system before connecting another component.
- Refer to the Owner's Manuals for the components to be connected to the TV/VCR/DVD.
- Set Dolby Digital to OFF for audio output in the setup mode. Playing a TV/VCR/DVD using incorrect settings may generate noise distortion, and may also damage the speakers.

## CONNECTING TO A DOLBY DIGITAL DECODER (for DVD)

If using this TV/VCR/DVD to play a DVD disc in a 5.1 channel Dolby Digital surround format, the TV/VCR/DVD outputs a DOLBY DIGITAL Data stream from its COAXIAL digital audio out jack. By hooking the player up to a Dolby Digital decoder, you can enjoy a more convincing, realistic ambience with powerful and high-quality surround sound as enjoyed in movie theaters.

Use audio coaxial digital cables available at retail for the audio connections.

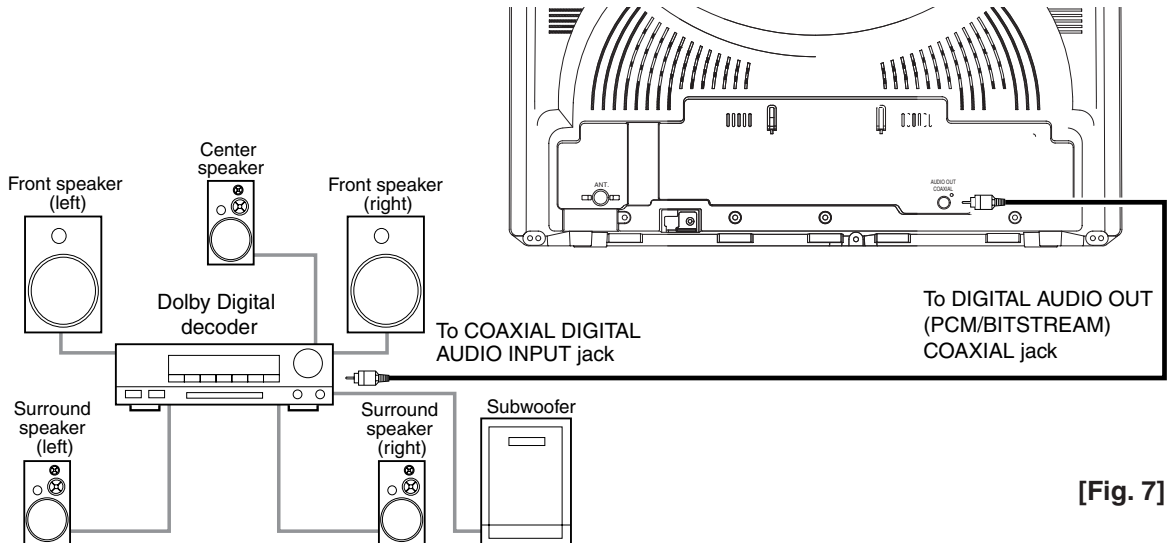

[Fig. 7]

### NOTES:

- Be sure to turn off the power to all components in the system before connecting another component.
- Refer to the Owner's Manuals for the components to be connected to the TV/VCR/DVD.
- If connected to a Dolby Digital decoder, set DOLBY DIGITAL to ON for audio output in the setup mode. (See page 45 to set DOLBY DIGITAL to ON.)
- Unless connected to a Dolby Digital decoder, set DOLBY DIGITAL to OFF for audio output in the setup mode. Playing a TV/VCR/DVD using incorrect settings may generate noise distortion, and may also damage the speakers.

Manufactured under license from Dolby Laboratories. "Dolby" and the double-D symbol are trademarks of Dolby Laboratories.



## SET UP FOR USE

## SELECTING THE LANGUAGE

TV/VCR

**1 Plug in the TV/VCR/DVD power cord**

Plug the TV/VCR/DVD power cord into a standard AC outlet.

**NOTE:**

- If some digits appear in the corner of the screen, press the POWER button without unplugging the power cord.

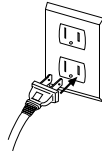
**Make sure ...**

- Press select button to select TV/ VCR mode, or make sure TV/ VCR lights on.
- Press the POWER button to turn on the TV/VCR/DVD.

**NOTE:** This function effects only the language on the screen menu and not the audio source.

**2 Select "LANGUAGE"**

Press the SETUP button on the remote control.

Press the Arrow button ▲ or ▼ to point to "LANGUAGE".

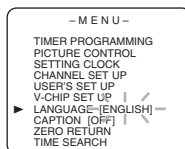
**3 Select "ENGLISH", "ESPAÑOL" or "FRANÇAIS"**

Select "ENGLISH", "ESPAÑOL"= Spanish or "FRANÇAIS"= French using the ENTER button.

**4 Exit the Language mode**

Press the SETUP button on the remote control to return to TV mode.

**NOTE:** If for some reason the menu is in Spanish or French, press the SETUP button on the remote control, press the Arrow button ▲ or ▼ to point to "IDIOMA [ESPAÑOL]" or "LANGAGE [FRANÇAIS]", then press the ENTER button, then press the SETUP button on the remote control.

CLOCK SET UP  
(AUTO / MANUAL)

TV/VCR

The TV/VCR/DVD clock must be set correctly before VCR timer recording is possible. It is suggested that the clock be set manually when first setting up the TV/VCR/DVD. Then, set to [ON] the auto clock setting which will periodically correct the setting if necessary.

**NOTE:** If you cannot receive a station with time signals, auto clock setting cannot be performed. Use manual setting only.

## MANUAL CLOCK SETTING

**Make sure ...**

- The TV/VCR/DVD is turned on.

In the example below, the clock is to be set to:

DATE                    May 6th, 2004  
SETTING TIME        5:40PM

**1 Select "SETTING CLOCK"**

Press the SETUP button on the remote control.

Press the Arrow button ▲ or ▼ to point to "SETTING CLOCK". Then, press the ENTER button.

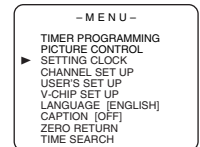
**2 Select "MANUAL CLOCK SET"**

Press the Arrow button ▲ or ▼ to point to "MANUAL CLOCK SET".

Then, press the ENTER button.

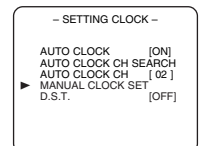
**3 Select the month**

Press the Arrow button ▲ or ▼ until your desired month appears. (Example: May → 05)

Then, press the Arrow button ►. (Or press the Arrow button ◀ to go back one step.)

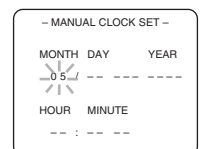
**4 Select the day**

Press the Arrow button ▲ or ▼ until your desired day appears. (Example: 6th → 06)

Then, press the Arrow button ►.

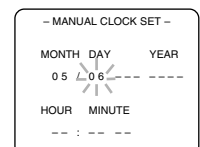

## 5 Select the year

Press the Arrow button ▲ or ▼ until your desired year appears. (Example: 2004)

Then, press the Arrow button ►.

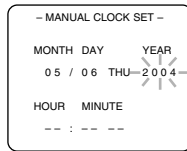

## 6 Select the hour

Press the Arrow button ▲ or ▼ until your desired hour appears. (Example: 5, PM)

Then, press the Arrow button ►.

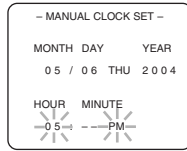

## 7 Select the minute

Press the Arrow button ▲ or ▼ until the desired minute appears. (Example: 40)

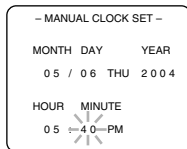

## 8 Start the clock

Press the SETUP button on the remote control.

Although seconds are not displayed, they begin counting from 00 when you press the SETUP button on the remote control. Use this feature to synchronize the clock with the correct time.

### NOTE:

When unplugging the AC cord or if there is a power failure for more than 3 seconds, you may have to reset the clock.

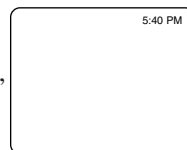

## TO CHANGE CLOCK SETTING

If you want to change the clock,

- 1) Follow steps [1] and [2].
- 2) Select where you want to change using the Arrow button ►.
- 3) Enter correct numbers using the Arrow button ▲ or ▼.
- 4) Press the SETUP button on the remote control to start the clock.

### PLEASE NOTE:

If there is no local PBS station in your area or on your cable system, select "AUTO CLOCK" and press the ENTER button to turn [OFF] this function. Then you can manually adjust the clock.

## AUTOMATIC CLOCK SETTING

### Make sure ...

- The TV/VCR/DVD is turned on.
- Confirm the TV/VCR/DVD is receiving a RF (Radio Frequency) signal from either an antenna or cable system connection using the ANT. terminal on the rear of the TV/VCR/DVD.

### NOTE:

- If a cable converter box is being used, make sure it is powered on.
- You must use the TV/VCR/DVD remote control to perform the clock setting procedure.
- If the TV/VCR/DVD is connected directly to a cable converter box or satellite box, the local PBS station must be selected on the cable box itself, and the TV/VCR/DVD must be set to the output channel of the cable converter box or satellite box (usually channel 3 or 4), to be able to set up or correct the clock automatically.

## 1 Select "SETTING CLOCK"

Press the SETUP button on the remote control.

Press the Arrow button ▲ or ▼ to select "SETTING CLOCK".

Press the ENTER button to enter "SETTING CLOCK" menu.

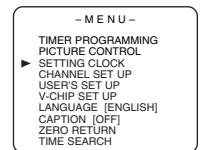

## 2 Set "AUTO CLOCK" to [ON]

Press the Arrow button ► until "AUTO CLOCK [ON]" appears.

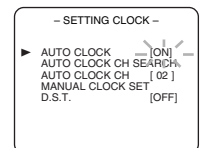

## 3 Begin "AUTO CLOCK CH SEARCH"

Press the Arrow button ▼ to select "AUTO CLOCK CH SEARCH".

Press the ENTER button.

- The TV/VCR/DVD is now searching for the station which contain the auto clock set signal. The search for a signal may take up to 20 seconds per channel.
- " \_ " appears at the lower left of the screen when the search has ended.
- Auto Clock station- write down the number(s) that appear on the screen. These are the auto clock station(s) in your area. See step [4] on page 17.
- If no number(s) appear on the TV screen, there are no stations in your area which contain the Auto Clock signal. Auto Clock Setting is not possible. Please use Manual Clock Setting on page 17. Press the SETUP button to exit the screen.

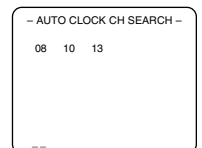
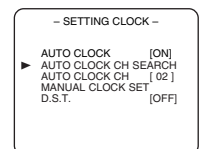

**NOTE:** During Auto Clock CH Search, the picture may be distorted. This is normal.

## DAYLIGHT-SAVING TIME

TV/VCR

### 4 Enter the channel number that contains the Automatic Clock Setting Signal

Press the SETUP button on the remote control.

Press the Arrow button ▲ or ▼ to select “SETTING CLOCK”.

Press the ENTER button to enter “SETTING CLOCK” menu.

Press the Arrow button ▼ to select “AUTO CLOCK CH”.

Press the ENTER button or the Arrow button ◀ or ▶ until you locate Auto Clock Set station number. See step [3] on page 16.

Press the SETUP button to exit the screen.

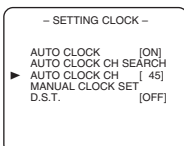
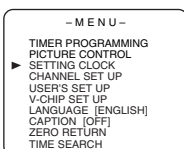

### 5 Turn off the TV/VCR/DVD

Once the TV/VCR/DVD is turned off, it will periodically check and set the correct date and time.

Select this feature and the TV/VCR/DVD's clock automatically will advance one hour in April, then reverse one hour in October.

When Daylight-Saving Time is ON, the clock will change automatically as follows:

- **First Sunday of April** : At 2 AM the clock immediately changes to 3 AM. Any timer programming you have set to occur between 2 AM and 3 AM will not record.
- **Last Sunday of October** : At 2 AM the clock immediately changes to 1 AM.

**Make sure ...**

- Press the POWER button to turn on the TV/VCR/DVD.

### 1 Select “SETTING CLOCK”

Press the SETUP button on the remote control.

Press the Arrow button ▲ or ▼ to point to “SETTING CLOCK”.

Then, press the ENTER button.

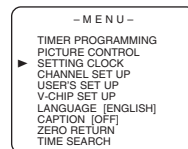

### 2 Set “D.S.T.” (Daylight-Saving Time) to [ON]

Press the Arrow button ▲ or ▼ to point to “D.S.T.”.

Then, press the ENTER button until [ON] appears.

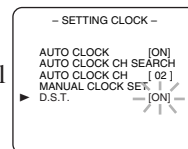

### 3 Exit the Daylight-Saving Time mode

Press the SETUP button on the remote control to return to TV mode.

## TO CANCEL THE DAYLIGHT-SAVING TIME

Repeat steps [1] to [2], select [OFF] using the ENTER button.

## CHANNEL SET UP

TV/VCR

You can program the tuner to scan all the channels you receive in your area.

**NOTE:** Channel memory programming is NOT needed when connected to a cable box or satellite box. Just select the TV/VCR/DVD channel selector to the output channel of the cable box or satellite box (Ex CH3). Then select the channel to be viewed on the Cable Box or Satellite Box.

### Make sure ...

- Press the POWER button to turn on the TV/VCR/DVD.

### 1 Select "CHANNEL SET UP"

Press the SETUP button on the remote control.

Press the Arrow button ▲ or ▼ to point to "CHANNEL SET UP".

Then, press the ENTER button.

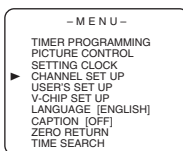

### 2 Begin auto ch programming

Press the Arrow button ▲ or ▼ to point to "AUTO CH PROGRAMMING".

Then, press the ENTER button.

The tuner scans and memorizes all the active channels in your area.

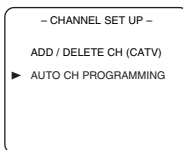

### 3 After scanning

The tuner stops on the lowest memorized channel.

- When AUTO CH PROGRAMMING is activated where there is no TV signal input, "NO TV SIGNALS" will appear on the display after the completion of the channel scanning.
- The TV/VCR/DVD may recognize TV channels to be CATV channels by the receiving conditions. In this case, try auto ch programming again in the fine receiving conditions.

## DELETING (OR ADDING) CHANNEL

TV/VCR

The channels you no longer receive or seldom watch can be deleted from the memory. (Of course, you can add the deleted channel into the memory again.)

### 1 Select "CHANNEL SET UP"

Press the SETUP button on the remote control.

Press the Arrow button ▲ or ▼ to point to "CHANNEL SET UP".

Then, press the ENTER button.

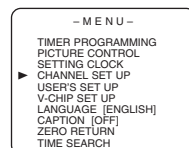

### 2 Select "ADD/DELETE CH"

Press the Arrow button ▲ or ▼ to point to "ADD/DELETE CH".

Press the ENTER button.

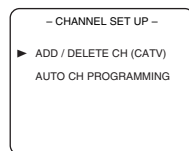

### 3 Enter the desired channel number

Press the Arrow button ▲ or ▼ until your desired channel number appears. (You can also use the number buttons or the CHANNEL ▲ or ▼ button to enter it) (Example: CH8)

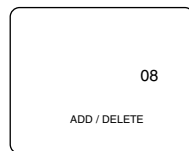

- When selecting cable channels which are higher than 99, press the +100 button first, then, press the last two digits. (Example: to select channel 125, first press the +100 button then press "2" and "5").
- You must proceed single-digit channel numbers with a zero (Example: 02 ... 09).

### 4 Delete (or add) it from (into) memory

Press the ENTER button. The channel number changes to light red. The channel is deleted from memory.

- To delete another channel, repeat steps [3] and [4].
- If you press the ENTER button again, the channel is memorized again.

**Added channel: Light blue.**  
**Deleted channel: Light red.**

### 5 Exit the channel setup mode

Press the SETUP button on the remote control to returns to TV mode.

**NOTE:** To confirm that channel(s) has been deleted or added, press the CHANNEL ▲ or ▼ button.

# TV OPERATION

## WATCHING A TV PROGRAM

TV/VCR

### 1 Turn on the TV/VCR/DVD

Press the POWER button to turn on the TV/VCR/DVD.

### 2 Select the channel number

Press the CHANNEL button ▲ or ▼ to select your desired channel number or press the number on the remote control.

**Note for using the Number button on the remote control:**

- When selecting cable channels which are higher than 99, press +100 first, then, press the last two digits. (Example: to select channel 125, first press "+100" then press "2" and "5").
- You must precede single-digit channel numbers with a zero (For example: 02, 03, 04 and so on).

**Remember:** If the TV/VCR/DVD is connected to a cable box or satellite box, the TV/VCR/DVD must be on CH3 or CH4, then the channel to be viewed must be selected on the cable box or satellite box.

### 3 Adjust sound

Press the VOLUME button ▲ or ▼ to adjust the volume.

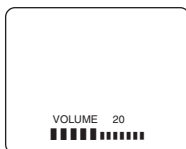

#### NOTES:

- If you press the CHANNEL button ▲ or ▼ in the DVD mode, you can change the TV channels. Even if you turn off the TV/VCR/DVD in the DVD mode, when you turn it on again, it will go into the TV/VCR mode.

## DEGAUSSING

TV/VCR

Magnetism from nearby appliances and speakers might affect the color of the TV picture.

If this happens, move this TV/VCR/DVD away from the appliance. If the color is still not correct, unplug the power cord, then plug it in again 30 minutes later or so.

## PICTURE CONTROL

TV/VCR

The TV/VCR/DVD's picture controls – **BRIGHT**, **CONTRAST**, **COLOR**, **TINT** and **SHARPNESS** – are preset to factory specifications. Although they are usually the best, you may need to make some further adjustments for a natural looking image.

#### NOTES:

- Procedures must be followed within 5 seconds or the Picture Control mode will be cancelled.
- When setting the Picture Control, the Game mode will be cancelled.

#### Make sure ...

- TV/VCR/DVD power must be turned on.

### 1 Select "PICTURE CONTROL"

Press the PICTURE button on the remote control.

### 2 Select item you want to adjust

Press the Arrow button ▲ or ▼ until desired control is displayed.

BRIGHT  
CONTRAST  
COLOR  
TINT  
SHARPNESS



### 3 Adjust the picture control

Press the Arrow button ◀ or ▶ to adjust to your desired level.

	Arrow button ◀	Arrow button ▶
<b>BRIGHT</b>	to decrease brightness	to increase brightness
<b>CONTRAST</b>	to decrease contrast	to increase contrast
<b>COLOR</b>	to pale	to brilliant
<b>TINT</b>	to purple	to green
<b>SHARPNESS</b>	to soft	to clear

- **If there is a power failure of any kind, the TV/VCR/DVD will retain its memory for this feature.**

# CLOSED CAPTION SYSTEM

## TV/VCR

You can view specially labeled (cc) TV programs, movies, news, pre-recorded tapes with either a dialogue caption or text display.

**CAPTION mode:** By choosing the caption mode, you can watch dramas, movies and news while captioning the dialogues and the contents of news.

**TEXT mode:** By choosing the text mode, you can watch half screen text information if you want.

**1-2:** You may get these captions or text information by selecting either "1" or "2". Caption "2" is used, usually for a second language if available.

### NOTE:

Not all programs are broadcast with closed captions. Your TV/VCR/DVD is designed to provide error free closed captions from high quality antenna, cable and VCR signals. Conversely, poor quality signals are likely to result in caption errors or no captions at all. Common signal conditions which may cause captions errors are listed below:

- Automobile ignition noise
- Electric motor brush noise
- Weak snowy reception on TV screen
- Multiplex signal reception displaying picture ghosts or airplane flutter.
- Playback of poorly recorded or worn VCR tapes.

### NOTE:

If the TV/VCR/DVD displays a black box on the TV screen, this means that the TV/VCR/DVD is set to the TEXT mode. To clear screen, select [CAPTION1], [CAPTION2] or [OFF].



### Make sure ...

- TV/VCR/DVD's power must be turned on.

## 1 Select "CAPTION"

Press the SETUP button on the remote control.

Press the Arrow button ▲ or ▼ to point to "CAPTION".

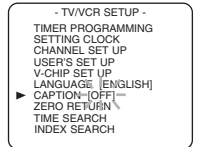

## 2 Select your desired caption menu

Press the ENTER button until your desired caption menu appears.

([CAPTION1], [CAPTION2], [TEXT1] or [TEXT2])

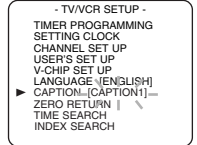

## 3 Exit the caption setting mode

Press the SETUP button on the remote control to return to TV mode.

## TO CANCEL THE CLOSED CAPTION SYSTEM

Repeat steps [1] and [2], select [OFF] using the ENTER button. Press the SETUP button on the remote control to return to TV mode.

## WHEN THE CLOSED CAPTION MODE IS ON

The On-Screen Display will disappear after 5 seconds.

- It will also disappear when the MUTE button is pressed, and when the PAUSE button is pressed while recording.
- If there is a power failure of any kind, the TV/VCR/DVD will retain its memory for this feature.



# V-CHIP SET UP

## TV/VCR

### V-CHIP SET UP

#### Make sure ...

- TV/VCR/DVD is turned on.

#### 1 Select "V-CHIP SET UP"

Press the SETUP button on the remote control.

Press the Arrow button ▲ or ▼ to select "V-CHIP SET UP".

Then, press the ENTER button.

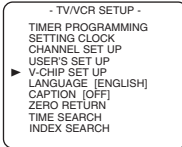

#### 2 Enter Access code

Use the number buttons on the remote control to enter the access code.

- For the first time set-up or in the event the TV/VCR/DVD has lost power, enter the default code of the numbers: 0000.

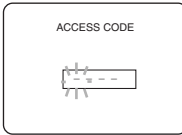

#### 3 Select "TV RATING"

Press the Arrow button ▲ or ▼ to select "TV RATING".

Then, press the ENTER button.

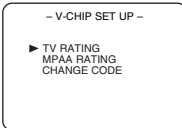

#### 4 Blocking TV programs

Press the Arrow button ▲ or ▼ to select "TV rating" that you wish to block.

Press the ENTER button to turn it [BLOCK].

- When you select the rating category and turn it [BLOCK], the higher rating will turn [BLOCK] automatically. Also, the lower rating will turn [VIEW] automatically.
- When you turn "TV-Y" to [VIEW], then all ratings will turn to [VIEW] automatically.

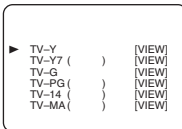

Selection	Rating Category Explanations
TV-Y	Appropriate for all children
TV-Y7	Appropriate for children seven and older
TV-G	General Audience
TV-PG	Parental Guidance suggested.
TV-14	Unsuitable for children under 14
TV-MA	Mature audience only

#### 5 Exit the V-Chip setting mode

Press the SETUP button on the remote control to exit the screen.

### V-CHIP SET UP SUB RATINGS

When you select the ratings of TV-Y7,TV-PG,TV-14 or TV-MA you will have the option of selecting sub rating categories.

#### 1 Select "V-CHIP SET UP"

Press the SETUP button on the remote control.

Press the Arrow button ▲ or ▼ to select "V-CHIP SET UP". Then, press the ENTER button.

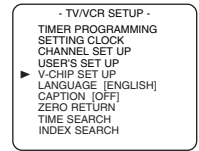

#### 2 Enter Access code

Use the number buttons on the remote control to enter the access code. (Default code is 0000.)

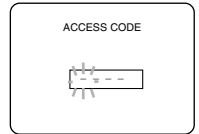

#### 3 Select "TV RATING"

Press the Arrow button ▲ or ▼ to select "TV RATING".

Then, press the ENTER button.

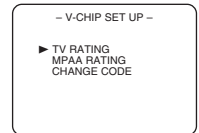

#### 4 Selecting "Sub-Ratings"

Press the Arrow button ▼ to select the sub-rating you wish to block. Then, press the ENTER button twice.

- When you select [TV-Y7]:

Press the Arrow button ▼ or ▲ to select "FV" (Fantasy Violence). Then, press the ENTER button to select [BLOCK] or [VIEW].



- When you select [TV-PG], [TV-14] or [TV-MA]:

Press the Arrow button ▼ or ▲ to select "D"(Suggestive Dialog), "L"(Coarse Language), "S"(Sexual Situation), or "V"(Violence). Then, press the ENTER button to select [BLOCK] or [VIEW].

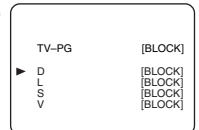

**Note:** When you select [TV-MA], "D" does not appear on the TV screen.

- The sub-ratings which set to [BLOCK] appears next to the rating category in the TV rating menu.

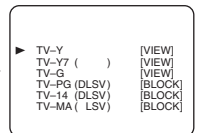

#### 5 Exit the V-Chip setting mode

Press the SETUP button on the remote control to enter the setting and exit the screen.

## CHANGING V-CHIP BLOCKED PROGRAMMING

**Note:** To change the rating, the TV must be turned on a station that is not protected. If the (PROTECTED) appears on the screen, please change the channel to a station that is not protected.

- 1) Follow steps [1] and [2].
- 2) Press the Arrow button ▲ or ▼ to select “TV RATING”. Then, press the ENTER button. Select a TV rating to be unblocked by pressing the Arrow button ▲ or ▼.  
Then press the ENTER button to unblock the rating.
- 3) Press the SETUP button on the remote control to exit the screen.

## MPAA RATING SET UP

### 1 Select “V-CHIP SET UP”

Press the SETUP button on the remote control.

Press the Arrow button ▲ or ▼ to select “V-CHIP SET UP”. Then, press the ENTER button.

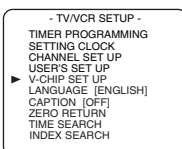

### 2 Enter Access code

Use the number buttons on the remote control to enter the access code.

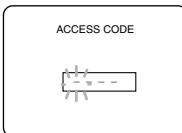

### 3 Select “MPAA RATING”

Press the Arrow button ▲ or ▼ to point to “MPAA RATING”. Then, press the ENTER button.

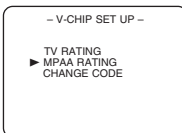

### 4 Select your desired item

Press the Arrow button ▲ or ▼ to point to your desired item.

Then, press the ENTER button to select [BLOCK] or [VIEW].

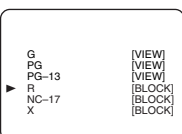

Selection	Rating Category Explanations
G	General Audience
PG	Parental Guidance suggested.
PG-13	Unsuitable for children under 13
R	Restricted; under 17 requires accompanying parent or adult guardian
NC-17	No one under 17 admitted
X	Mature audience only

- When you select the rating category and turn it [BLOCK], the higher rating will turn [BLOCK] automatically. Also, the lower rating will turn [VIEW] automatically.
- When you turn “G” to [VIEW], then all ratings will turn to [VIEW] automatically.

### 5 Exit the V-Chip setting mode

Press the SETUP button on the remote control to exit the screen.

## CHANGE ACCESS CODE

To change access code, follow the steps.

### 1 Select “V-CHIP SET UP”

Press the SETUP button on the remote control.

Press the Arrow button ▲ or ▼ to select “V-CHIP SET UP”.

Then, press the ENTER button.

### 2 Enter Access code

Use the number buttons on the remote control to enter the access code.

The default code is 0000.

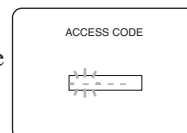

### 3 Select “CHANGE CODE”

Press the Arrow button ▲ or ▼ to select “CHANGE CODE”. Then, press the ENTER button.

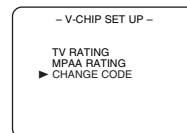

### 4 Enter New code

Use the number buttons to enter your desired access code in the NEW CODE space. Then enter the same code in the CONFIRM CODE space. V-CHIP SET UP screen appear on the screen.

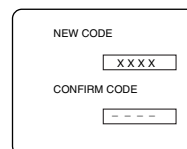

- If you enter wrong code, repeat step 4, making sure you enter the same new code exactly in the confirm code space.

### 5 Exit the V-Chip setting mode

Press the SETUP button on the remote control to exit the screen.

**Note:** If you unplug the power cord or power failure occurs, the changed access code will be lost and will return to default (0000). Change your access code again as necessary.

# MTS(Multi-Channel Television sound)SYSTEM

You can record or listen to a program in MTS stereo.

## CHECKING THE SELECTED MTS MODE

**TV/VCR**

When you play a VHS tape, or receive a broadcast on the TV/VCR/DVD tuner channel you are watching, the status shown below will appear when you press the DISPLAY button on the remote control.

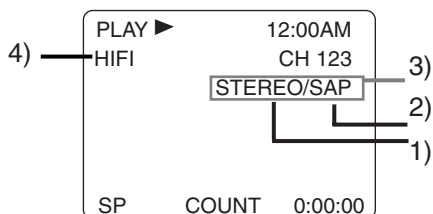

<b>SAP</b>	Second Audio Program, which means your program, can also be received in a second language or sometimes a radio station.
<b>HIFI</b>	High Fidelity which produces better sound than standard stereo TV/VCR/DVDs.

- 1) When a program is broadcast in stereo, STEREO appears on the TV screen.
- 2) When a program is broadcast in second audio, SAP appears on the TV screen.
- 3) When a program broadcast both in stereo and second audio, STEREO and SAP appear on the TV screen.

**NOTE:** Although a program may be broadcast in both stereo and second audio, you cannot record in both stereo and second audio at the same time.

- 4) While the TV/VCR/DVD is set in HIFI stereo mode and playback mode. HIFI appears on the TV screen. While the TV/VCR/DVD is set in monaural(MONO) mode, HIFI disappears from the TV screen.

**NOTE:** If you play non-HIFI tapes while the TV/VCR/DVD is set in HIFI, HIFI will disappear from the TV screen and the TV/VCR/DVD will play automatically in monaural.

## MTS RECORDING/MONITOR MODE

**TV/VCR**

Type of broadcast	Display on the TV screen	STEREO/SAP SELECTION	Hi-Fi audio track(2-channel)		Normal audio track
			L-channel	R-channel	
Regular (monaural audio)	-None-	-Invalid-	Mono	Mono	Mono
Stereo broadcast	STEREO	-Invalid-	L	R	L+R
Bilingual broadcast	SAP	STEREO*	Main audio program	Main audio program	Main audio program
		SAP*	Sub audio program	Sub audio program	Sub audio program
Stereo & Bilingual broadcast	STEREO SAP	STEREO*	L	R	L+R
		SAP*	sub audio program	sub audio program	sub audio program

\*You must select the recording mode in TV AUDIO [STEREO] or [SAP] when you record a broadcast.

# SELECTING THE MTS SYSTEM

TV/VCR

## Make sure ...

- TV/VCR/DVD power must be turned on.

## TO SELECT HIFI MODE

### 1 Select "USER'S SET UP"

Press the SETUP button on the remote control.

Press the Arrow button ▲ or ▼ to point to "USER'S SET UP". Then, press the ENTER button.

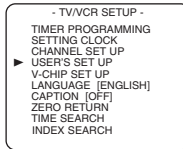

### 2 Select "VCR AUDIO"

Press the Arrow button ▲ or ▼ to point to "VCR AUDIO".

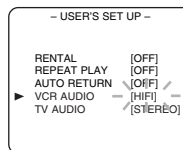

### 3 Select [HIFI]

Press the ENTER button until [HIFI] appears.

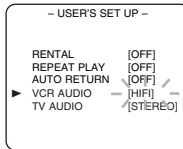

### 4 To return to TV mode

Press the SETUP button on the remote control to return to TV mode.

## NOTES:

- Normally, "HIFI" should be selected for playback with HIFI sound.
- When you play non-HIFI tapes, the TV/VCR/DVD will play automatically in the monaural mode.
- The TV/VCR/DVD records automatically MTS broadcasts in HIFI stereo sound unless you select SAP mode recording before you begin recording.

## TO SELECT MONO MODE

You can change the selection to "MONO" if you want to listen to HIFI tapes in normal audio playback.

- 1) Press the SETUP button on the remote control.  
Press the Arrow button ▲ or ▼ to point to "USER'S SET UP". Then, press the ENTER button.
- 2) Press the Arrow button ▲ or ▼ to point to "VCR AUDIO".
- 3) Press the ENTER button until [MONO] appears.
- 4) Press the SETUP button on the remote control to return to TV mode.

## TO SELECT STEREO, SAP, OR MONO

### 1 Select "USER'S SET UP"

Press the SETUP button on the remote control.

Press the Arrow button ▲ or ▼ to point to "USER'S SET UP".

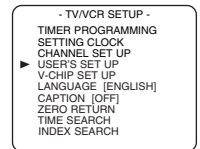

### 2 Select "TV AUDIO"

Press the Arrow button ▲ or ▼ to point to "TV AUDIO".

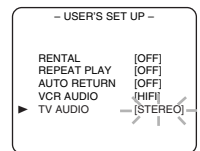

### 3 Select [STEREO], [SAP], or [MONO]

Press the ENTER button until [STEREO], [SAP], or [MONO] appears.

### 4 To return to TV mode

Press the SETUP button on the remote control to return to TV mode.

## NOTES:

- You must select the recording mode, either TV AUDIO [STEREO] or [SAP] when you record a broadcast.  
Refer to "MTS RECORDING/MONITOR MODE".
- If you select second audio when second audio is not available, the TV/VCR/DVD will record normal audio.
- The TV/VCR/DVD records automatically MTS broadcasts in HIFI stereo sound unless you select SAP mode recording before you begin recording.

# VIDEO CASSETTE

This TV/VCR/DVD will operate with any cassette that has the **VHS** mark. For best results, we recommend the use of high-quality tapes. Do not use poor quality or damaged tapes.

## PRECAUTIONS

- Avoid moisture. Moisture condensation may occur on the tape if it is moved from a cold place to a warm place or visa versa. Before using a tape with these conditions, to avoid damage of the tape and your TV/VCR/DVD, wait until the tape has warmed to room temperature and the moisture has evaporated.
- Avoid extreme heat, high humidity and magnetic fields.
- Do not tamper with the cassette mechanism.
- Do not touch the tape with your fingers.

## TWO DIFFERENT TAPE SPEEDS

Before recording, select the tape speed from : **SP mode** (Standard Play) or **SLP mode** (Super Long Play).

The table below shows the maximum recording/playback time using T60, T120 or T160 tapes in each mode.

Tape Speed	Recording/Playback Time			
	Type of tape	T60	T120	T160
SP mode		1 hour	2 hours	2-2/3 hours
SLP mode		3 hours	6 hours	8 hours

**Note:** You can play back a tape recorded in LP mode (Long Play).

## INSERTING A CASSETTE

Insert the cassette in the direction as shown. Push in gently, but continuously, on the center-back of the cassette until it is drawn into the TV/VCR/DVD. The TV/VCR/DVD will automatically turn on.

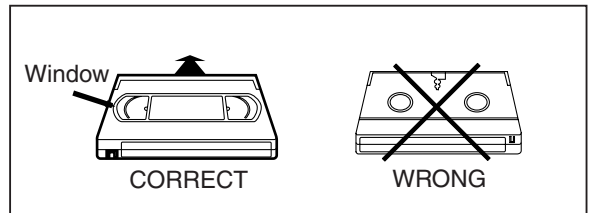

## REMOVING A CASSETTE

- 1) In the Stop mode, press the STOP/EJECT button on the TV/VCR/DVD. The cassette will eject.
- 2) Pull the cassette out of the cassette compartment.
- 3) Store the cassette in its case as shown.

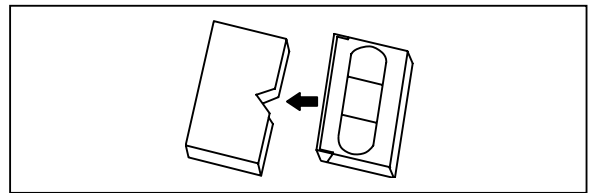

## ERASE PREVENTION

You can prevent accidental erasing of recording by breaking off the tab on the back edge of the cassette.

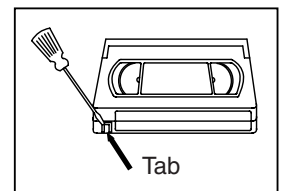

If you decide to record on the tape again, cover the hole with plastic tape.

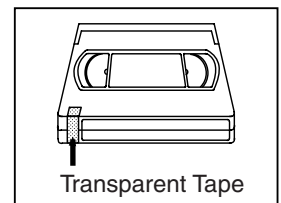

## NOTE:

- In DVD mode, Whether the cassette is with tab or without tab you insert, it doesn't start playing until you press the PLAY button.  
In TV/VCR mode, if th cassette without tab is inserted, playback will automatically start.

# PLAYBACK

## NORMAL PLAYBACK

TV/VCR

### Make sure ...

- TV/VCR/DVD power must be turned on.

### 1 Insert a prerecorded tape

If the erase-protection tab has been removed, the TV/VCR/DVD will start playback automatically.

### 2 To begin playback

Press the PLAY button.



### 3 To stop playback

Press the STOP button when playback is completed.



### NOTES:

- If you press the PLAY button (of the TV/VCR side) in the DVD mode, you can start the VCR playback.
- If you press the SELECT button during the VCR playback, it will stop and the mode will change to the DVD mode. In addition, the same function operates with the DVD side PLAY button or the OPEN/CLOSE button.

## TRACKING ADJUSTMENT

TV/VCR

- Tracking adjustment will be set automatically (Digital Tracking function) when you start playback.
- However when playing pre-recorded tapes or tapes recorded on other VCR, noise lines (black and white streaks) may appear on the playback picture. If this occurs, you can adjust the tracking control manually by pressing the CHANNEL button ▲ or ▼ until the streaks disappear. To return to the DTR function, stop the tape once and start playback again.
- You can reduce the noise lines by pressing the CHANNEL button ▲ or ▼ in slow mode, too. Tracking adjustment in Slow mode will not be set automatically.

## SLOW MOTION

TV/VCR

Press the PAUSE button, then press F.FWD button to start the playback in slow motion. The TV/VCR/DVD mutes the sound during slow motion. Press the PLAY button to return to normal playback.

**NOTE:** If it is left in the Slow mode for more than five minutes, the TV/VCR/DVD will automatically go into the Stop mode.

## PICTURE SEARCH

TV/VCR

This feature is very useful in finding or skipping over a particular scene on a tape. In this mode, the sound will be muted.

- 1) You may view a video tape at a high speed in either a forward or reverse direction by pressing the F.FWD or REW button during playback. (in the SP / LP / SLP modes)

### NOTE:

- If you press the F.FWD or REW button on the front panel in the DVD mode, the VCR forward or reverse will start. Please press the STOP / EJECT button once to stop it, twice to eject it.
- 2) Press it again and the TV/VCR/DVD will now search in super high speed. (in the LP / SLP modes only)

### NOTE:

- Tapes recorded in the SP or LP mode will display a noise bar on the TV screen and the picture may revert to Black and White. This is normal.
- 3) Press the PLAY button to return to normal speed.

## STILL PICTURE

TV/VCR

You can view a still picture on the TV screen during playback (the Still mode). Press the PAUSE button during playback. Only tapes recorded in the SLP mode will show the least amount of lines. Press the PLAY button to return to playback.

### NOTES:

- You can advance the picture one frame at a time by pressing the PAUSE button during the Still mode.
- If it is left in the Pause mode for more than five minutes, the TV/VCR/DVD will automatically switch to the Stop mode.

## VERTICAL HOLD CONTROL

TV/VCR

In the Pause/Still mode only, when the picture begins to vibrate vertically, stabilize the picture by pressing the CHANNEL button ▲ or ▼.

### NOTE:

If there are video noise lines on the screen, see Tracking Adjustment section.



# SPECIAL PLAYBACK

## Make sure ...

- TV/VCR/DVD's power must be turned on.
- Insert a prerecorded tape.

## RENTAL PLAYBACK

TV/VCR

This function enables you to improve the picture quality when playing back worn cassettes such as rented tapes.

### 1 Select "USER'S SET UP"

Press the SETUP button on the remote control.

Press the Arrow button ▲ or ▼ to point to "USER'S SET UP".

Then, press the ENTER button.

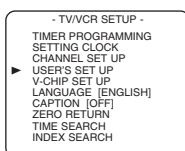

### 2 Set "RENTAL" to [ON]

Press the Arrow button ▲ or ▼ to point to "RENTAL".

Press the ENTER button until [ON] appears.

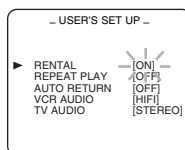

### 3 Exit the Rental setting

Press the SETUP button on the remote control to return to the TV mode.

### 4 Start playback

Press the PLAY button to start playback. "RENTAL PLAY ▶" appears.

- Once you select the Rental mode, it stays in effect even after you turn off the TV/VCR/DVD.

## TO CANCEL THE RENTAL MODE

Repeat steps [1] and [2], select [OFF] using the ENTER button on the remote control. Press the SETUP button on the remote control to return to TV mode.

**If there is a power failure of any kind, the TV/VCR/DVD will retain its memory for this feature.**

## AUTO REPEAT PLAYBACK

TV/VCR

The TV/VCR/DVD has the auto repeat function that allows you to repeat a tape indefinitely without touching the PLAY button.

**ALL REPEAT:** Repeat playback from the beginning to the end of the tape.

**BLANK REPEAT:** Repeat playback from the beginning to a blank part, which is blank for more than 10 seconds.

### 1 Select "USER'S SET UP"

Press the SETUP button on the remote control.

Press the Arrow button ▲ or ▼ to point to "USER'S SET UP".

Then, press the ENTER button.

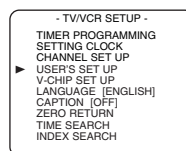

### 2 Select "ALL" or "BLANK"

Press the Arrow button ▲ or ▼ to point to "REPEAT PLAY".

Press the ENTER button repeatedly until your desired selection [ALL] or [BLANK] appears.

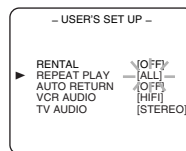

### 3 Exit the Repeat Play setting

Press the SETUP button on the remote control to return to the TV mode.

### 4 Start playback

Press the PLAY button to start the Repeat Play. "REPEAT PLAY ▶" appears.

- Once you select the Repeat Play mode, it stays in effect even after you turn off the TV/VCR/DVD.
- If the Rental mode is set [ON], the "RENTAL PLAY ▶" display has priority.

## TO CANCEL THE REPEAT PLAY MODE

Repeat steps [1] and [2], select [OFF] using the ENTER button on the remote control. Press the SETUP button on the remote control to return to TV mode.

**If there is a power failure of any kind, the TV/VCR/DVD will retain its memory for this feature.**

# SEARCH

## Make sure ...

- TV/VCR/DVD power must be turned on.
- Insert a tape.

## ZERO RETURN

TV/VCR

This function allows you to search easily a beginning point that you want to review by rewinding or fast forwarding.

### NOTE:

Zero Return **WILL NOT** work on a blank tape or a blank portion of a tape.

### 1 Stop a tape at your desired point

Rewind or fast forward the tape to the beginning point at which you want to review.

### 2 Reset the counter to 0:00:00

Press the C.RESET button repeatedly.

### 3 Begin recording or playback

Press the RECORD or PLAY button.

Press the STOP button when recording or playback is completed.

### 4 To activate "ZERO RETURN" mode

Press the SETUP button on the remote control.

Press the Arrow button ▲ or ▼ to point to "ZERO RETURN".

Then, press the ENTER button.

The counter will appear on the TV screen.

The tape will automatically stop when the counter returns to 0:00:00.

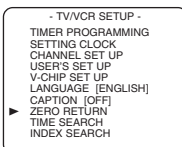

- This function will not operate in recording mode.
- This function is not operative when a cassette tape is not inserted in the TV/VCR/DVD.

*In the example below:* To watch a program before/ after 2 hour 50 minutes from the present position, in either direction.

### 1 Insert a tape

### 2 Select "TIME SEARCH" mode

Press the SETUP button on the remote control.

Press the Arrow button ▲ or ▼ to point to "TIME SEARCH".

Then, press the ENTER button.

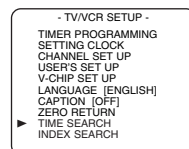

### 3 Enter your desired time

Press the Arrow button ▲ or ▼ until your desired time appears.

(Example: "2:50" stands for 2 hours 50 minutes)

If you wish to cancel the Time Search at this point, press the SETUP button on the remote control.

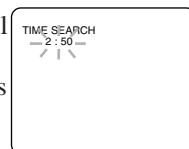

### 4 Begin Time Search

By pressing the Arrow button ◀ or ▶, the TV/VCR/DVD will rewind or fast forward to the specified point.

The time counts down as the searching progresses. When 0:00 is reached, the tape will start playback automatically.

### TO CANCEL THE TIME SEARCH at this point

Press the STOP/EJECT button on the TV/VCR/DVD or the STOP button on the remote control. This will delete the selected time.

## TIME SEARCH

TV/VCR

The Time Search function makes it possible to quickly advance the tape to your desired position simply by entering the exact amount of playback time you want to skip.

### NOTES:

- Time Search can be set up to a maximum of 9 hours 50 minutes (9:50) by 10 minutes at a time.

## INDEX SEARCH

TV/VCR

This feature provides a method of indexing the starting point so that it can be easily returned to in either fast forward or rewind mode.

- The index mark will be made automatically when the REC button is pressed. It will also be marked at the starting point of Timer recording and OTR.
- The index mark will not be recorded if the PAUSE button is pressed and released during recording.
- The time gap between making the index marks on the tape should be greater than 1 minute for SP recording, 2 minutes for LP recording and 3 minutes for SLP recording.
- In some cases, the index mark at the beginning of video tape cannot be detected.

**Example:** You are watching program number 4 and want to fast forward to program number 7. You must skip three programs.

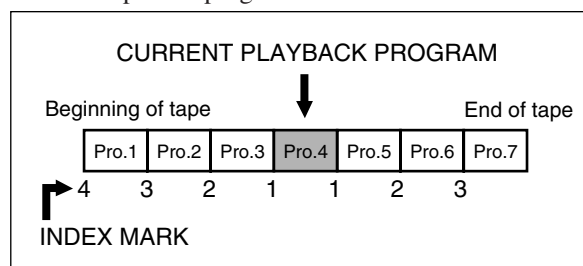

### 1 Select "INDEX SEARCH"

Press the SETUP button on the remote control.

Press the Arrow button ▲ or ▼ to point to "INDEX SEARCH". Then, press the ENTER button.

```
- TV/VCR SETUP -
TIMER PROGRAMMING
SETTING CLOCK
CHANNEL SET UP
USER'S SET UP
V-CHIP SET UP
LANGUAGE [ENGLISH]
CAPTION [OFF]
ZERO RETURN
▶ TIME SEARCH
INDEX SEARCH
```

### 2 Enter your desired number

Press the Arrow button ▲ or ▼ until the number of programs that you want to skip appears.

(Example: "03" for 3 programs)

- The Index Search mode will be canceled if the procedures are not activated in 30 seconds.

```
INDEX SEARCH
- 03 -
▶
```

### 3 Begin Index Search

Press the Arrow button ◀ or ▶. The TV/VCR/DVD begins rewinding or fast forwarding to the beginning of desired program.

**NOTE:** Every time an index signal is skipped, the number in the program indicator decreases by one.

### 4 After Index Search

When the preset program is reached, the TV/VCR/DVD will start playback automatically.

- A video cassette must be inserted in the TV/VCR/DVD for this function to work.
- The number of Index Searches can be set up to 20.
- This function will not operate in the recording mode.
- When you want to cancel the Index Search while in progress, press the STOP button.

## SPECIAL FEATURES

### REAL TIME TAPE COUNTER

TV/VCR

This shows the elapsed recording or playback time in hours, minutes, and seconds. (The displayed time will not change on a blank tape or blank portions on the tape.) The "—" indication will appear when the tape has rewound further than "0:00:00" on the tape counter.

### AUTO REWIND-EJECT

TV/VCR

- When the end of a tape is reached during recording, playback, or fast-forward, the tape will automatically rewind to the beginning. After rewinding finishes, the TV/VCR/DVD will eject the tape and turn itself to off.
- This function is operative when Repeat Play is set to the [OFF] position.
- The tape will not auto-rewind during timer recording or One Touch Recording.

# RECORDING

## Make sure ...

- TV/VCR/DVD power must be turned on.
- Insert a cassette tape with its erase prevention tab in place. (If necessary, rewind or fast forward the tape to the point at which you want to begin recording.)

## NOTES:

- This TV/VCR/DVD will ONLY record and view the same channel.
- This TV/VCR/DVD cannot record the contents from the built-in DVD.

## NORMAL RECORDING

TV/VCR

You can ONLY watch the same TV program that is being recorded.

### 1 Select the channel to be recorded

Press the number buttons on the remote control or the CHANNEL button ▲ or ▼.

**Remember:** If the TV/VCR/DVD is connected to a cable box or satellite box, the TV/VCR/DVD must be on CH3 or CH4, then the channel to be recorded must be selected on the cable box or satellite box.

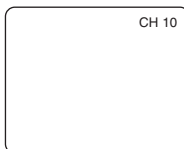

### 2 Select the tape speed

Press the SPEED button to select the desired tape speed (SP/ SLP).



### 3 Begin recording

Press the RECORD button.

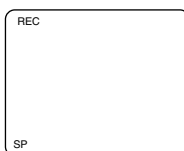

### 4 Stop recording

Press the STOP button when recording is completed.

## SKIPPING UNWANTED SCENES DURING RECORDING

TV/VCR

Press the PAUSE button to temporarily stop recording. Press the PAUSE or RECORD button to resume recording.

## NOTES:

- After five minutes, the TV/VCR/DVD will automatically switch to the Recording mode to prevent tape damage.
- If "CLOSED CAPTION (ON)" is selected, the On-Screen Display will appear for 5 seconds, then disappear.

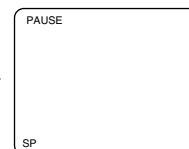

## OTR (One Touch Recording)

### TV/VCR

This function enables you to set a recording length simply by pressing the REC/OTR button on the TV/VCR/DVD.

#### Make sure ...

- TV/VCR/DVD power must be turned on.
- Insert a cassette tape with its erase prevention tab in place. (If necessary, rewind or fast forward the tape to the point at which you want to begin recording.)

#### NOTES:

- This function CANNOT be done from the remote control.
- Recording starts immediately when the REC/OTR button is pressed.
- When the REC/OTR button is pressed 18 times, the TV/VCR/DVD returns to the Normal Recording mode.
- To stop the OTR operation, press the STOP button on the TV/VCR/DVD or on the remote control.
- To show the remaining time, press the DISPLAY button on the remote control so that "OTR" appears on the TV screen. (It will show up momentarily then disappear.)
- Recording stops when 0:00 is reached.
- Please note that in the SLP mode maximum recording time, assuming the tape is started at the beginning, is 8 hours using T-160 (or 6 hours using T-120).
- If the tape runs out before the end time, the TV/VCR/DVD will switch to the Stop mode immediately, ejects the tape and turns itself off.
- If you press the POWER button during OTR, the TV/VCR/DVD continues recording until the selected length is reached.

### 1 Select the channel to be recorded

Press the number buttons on the remote control or the CHANNEL button ▲ or ▼.

**Remember:** If the TV/VCR/DVD is connected to a cable box or satellite box, the TV/VCR/DVD must be on CH3 or CH4, then the channel to be recorded is selected on the cable box or satellite box.

### 2 Select the tape speed

Press the SPEED button to select the desired tape speed (SP/SLP).

### 3 Begin OTR

Press the REC/OTR button on the TV/VCR/DVD as many times as needed. The recording length will be determined by the number of times you press the REC/OTR button. Each additional push will increase the recording time by 30 minutes. It is set up to 8 hours.

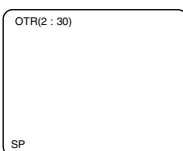

Push(es)	Display	Recording length
1 push		(normal recording)
2 pushes	0:30	30 minutes
3 pushes	1:00	60 minutes
↓	↓	↓
17 pushes	8:00	480 minutes

## COPYING A VIDEO CASSETTE (Requires a VCR or camcorder)

### TV/VCR

You can make copies of video tapes made by friends or relatives for your enjoyment.

**You can not copy a DVD to a videotape.**

**WARNING: Unauthorized recordings of copyrighted video tapes may be an infringement of copyright laws.**

Connect your TV/VCR/DVD and a Source (Playing) VCR using the following diagram.

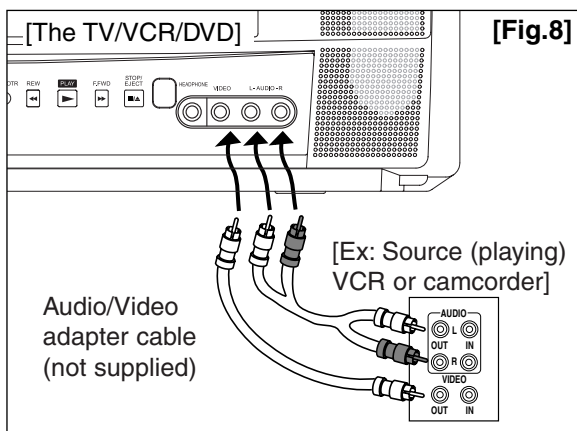

- 1) Insert a pre-recorded video cassette into the Source (Playing) VCR or camcorder.
- 2) Insert a blank video cassette, or one you want to record over, into the TV/VCR/DVD's cassette compartment.
- 3) Press the SPEED button on remote control for the TV/VCR/DVD to select the desired recording speed (SP/SLP).
- 4) Press the CHANNEL button ▲ or ▼ on the TV/VCR/DVD until "AUX" appears on the screen.
- 5) Press the RECORD button on the TV/VCR/DVD.
- 6) Begin playback of the tape in the source (Playing) VCR or camcorder.

**NOTE:** For best results during copying, use the TV/VCR/DVD's front panel controls whenever possible. The remote control might affect the source (Playing) VCR's playback operation.

- 7) To stop copying, press STOP/EJECT button on the TV/VCR/DVD, then stop the tape on the source VCR or camcorder.

# TIMER

## AUTOMATIC TIMER RECORDING

### TV/VCR

You may set the TV/VCR/DVD to start and end a recording while you are away. You can set 8 programs to record on specific days, daily or weekly within a 1 year period.

*In the example below, the timer is being set to record:*

DATE: July 4th, 2004  
 SETTING TIME: from 7:30PM to 8:50PM  
 CHANNEL: CH61  
 TAPE SPEED: SP

### Make sure ...

- If a cable box or satellite box is connected with the TV/VCR/DVD you will be limited to record only one channel. And the channel selector on the TV/VCR/DVD must be selected to the output channel of the boxes CH 3 or CH 4 and then the actual channel to be recorded must be selected on the boxes.
- Clock must be set to the correct time and date before setting the timer.
- TV/VCR/DVD power must be turned on to program it.
- Insert a cassette tape with its erase prevention tab in place. (If necessary, rewind or fast forward the tape to the point at which you want to begin recording.)
- The channel you want to record is properly set in advance. (See page 16.)

### Avoid over lap of programs ...

There is a chance that a program will not be recorded, when programs overlap;

- The program with an earlier start has priority.
- Once the earliest program finishes, the overlapping programs will begin recording in sequence.
- The illustration below demonstrates the sequence of recordings.

Program 1 10:00AM - 11:00AM  
 Program 2 9:00AM - 10:00AM  
 Program 3 9:30AM - 12:00PM

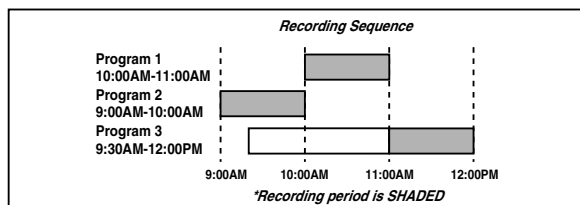

### 1 Select "TIMER PROGRAMMING"

Press the SETUP button on the remote control.

Confirm "TIMER PROGRAMMING" is pointed by pressing the Arrow button ▲. And press the ENTER button.

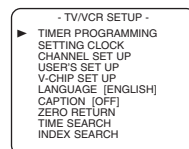

- If you have not yet set the clock, "MANUAL CLOCK SET" appears. If so, follow steps [3] to [8] on pages 15, 16. Then set the timer recording.

### 2 Select your desired program position (1~8)

Press the Arrow button ▲ or ▼ to select the desired program position.

Then, press the Arrow button ►.

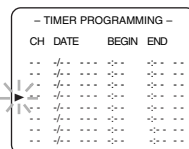

### 3 Set the channel number

Press the Arrow button ▲ or ▼ until the desired channel number appears. (Example: CH61)

Then, press the Arrow button ►.

**Remember:** If the TV/VCR/DVD is connected to a cable box or satellite box, the TV/VCR/DVD must be on CH3 or CH4, then the channel to be recorded is selected on the cable box or satellite box.

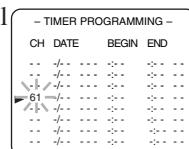

### 4 Select once, every day or weekly recording

#### For once recording :

Press the Arrow button ▲ (up) until the desired date appears. (Example: "7/04" for July 4th). Then, press the Arrow button ►.

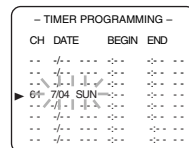

**For every day recording :** To record a TV program at the same time on the same channel every day. (Example: Monday through Sunday)

Press the Arrow button ▼ (down) until "EVERY DAY" appears. Then, press the Arrow button ►.

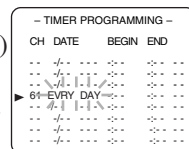

**For weekly recording :** To record a TV program at the same time on the same channel every week. (Example: every Monday)

Press the Arrow button ▼ (down) until "EVERY" and your desired day of the week appear together. Then, press the Arrow button ►.

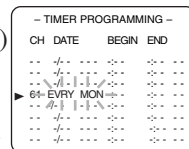



## TIMER PROGRAM EXTENSION

TV/VCR

### 5 Set beginning hour

Press the Arrow button ▲ or ▼ until the desired hour appears.  
(Example: “7, PM” for 7:30PM)  
Then, press the Arrow button ►.

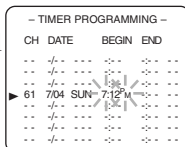

### 6 Set beginning minute

Press the Arrow button ▲ or ▼ until the desired minute appears.  
(Example: “30” for 7:30PM)  
Then, press the Arrow button ►.

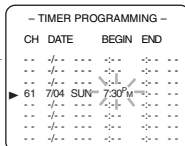

### 7 Set end hour

Press the Arrow button ▲ or ▼ until the desired hour appears.  
(Example: “8, PM” for 8:50PM)  
Then, press the Arrow button ►.

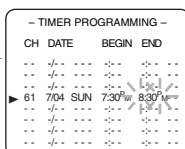

### 8 Set end minute

Press the Arrow button ▲ or ▼ until the desired minute appears.  
(Example: “50” for 8:50PM)  
Then, press the Arrow button ►.

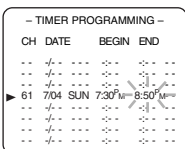

### 9 Set the tape speed

Press the Arrow button ▲ or ▼ until the desired tape speed appears. (Example: SP)

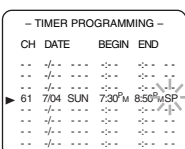

### 10 Finish setting the program

Press the ENTER or RETURN button. The program is now completed.

- To set another program, repeat steps [2] to [10].
- Press the SETUP button on the remote control to return to original mode.

### 11 Set the timer

Press the POWER button to set automatic timer recording. The RECORDING indicator lights up.

- You must turn off the TV/VCR/DVD to activate automatic timer recording.

If power is not turned off and you continue watching TV, “TIMER REC STANDBY” starts flashing on the TV screen 2 minutes before the programmed start time.

To shift the time schedule of an automatic timer recording.

- 1) Press the POWER button.
- 2) Repeat step [1] on page 32.
- 3) Press the RECORD button and select the desired program using the Arrow button ▲ or ▼.
- 4) Press the RECORD button again.

Each additional push will shift forward the begin/end time for recording by 10 minutes. When the recording is already in progress, each additional push will shift forward the end time only. If you want to cancel while setting, press the PAUSE button on the remote control. The recording time returns to the original time.

**NOTE:** When you shift forward the time schedule during recording, the recording speed will automatically be set to the SLP mode.

- 5) Press the ENTER or RETURN button to exit the setting menu. Then press the SETUP button on the remote control to return to original mode.

### TO CORRECT A PROGRAM

- **While setting a program;** press the Arrow button ◀ to go back one step and enter the correct numbers using the Arrow button ▲ or ▼.
- **After setting a program;**
  - 1) Press the POWER button.
  - 2) Repeat steps [1] - [2] on page 32.
  - 3) Press the Arrow button ► (or press the Arrow button ◀ to go back one step) until the part you want to correct begins flashing, then make the changes pressing the Arrow button ▲ or ▼.
  - 4) Press the POWER button to set automatic timer recording.

### TO CANCEL AN AUTOMATIC TIMER RECORDING

- **After setting a program;**
  - 1) Press the POWER button.
  - 2) Repeat steps [1] ~ [2] on page 32 and select a program you want to cancel.
  - 3) Press the C.RESET button.
  - 4) Press the SETUP button on the remote control to return to TV mode.
- **While recording is in progress;**
  - 1) Press the POWER button.
  - 2) Press the STOP/EJECT button on the TV/VCR/DVD.

## TO CHECK THE BEGIN/END TIME

- 1) Press the POWER button so that the RECORDING indicator goes off.
- 2) Press the SETUP button on the remote control.
- 3) Confirm "TIMER PROGRAMMING" is pointed.
- 4) Press the ENTER button. The details of programs appear on the TV screen.
- 5) Press the SETUP button on the remote control to return to TV mode.

## HINTS FOR AUTOMATIC TIMER RECORDING

### TV/VCR

- Make sure the channel you want to record is properly set in advance.
- It is not necessary to press the RECORD button for timer recording.
- Recording begins automatically at the Start time.
- The display will not be turned on when the programmed recording begins. To watch the currently recorded TV program or to play a DVD disc, press the POWER button to turn on the display and use the SELECT button to choose the TV/VCR mode or the DVD mode.
- The erase-prevention tab on the cassette must be in place (or you must put tape over the hole).
- If the erase-prevention tab is removed, the cassette will be ejected when the POWER button is pressed to off.
- If the tape runs out before the end time, the TV/VCR/DVD will switch to the Stop mode immediately, and the tape will be ejected.

## AUTO RETURN

### TV/VCR

With this feature, after timer recording is finished, the beginning of the recorded program(s) can be searched for automatically.

### 1 Select "USER'S SET UP"

Press the SETUP button on the remote control.

Press the Arrow button ▲ or ▼ to point to "USER'S SET UP".

Then, press the ENTER button.

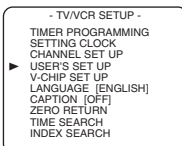

### 2 Set "AUTO RETURN" to [ON]

Press the Arrow button ▲ or ▼ to point to "AUTO RETURN".

Press the ENTER button until [ON] appears.

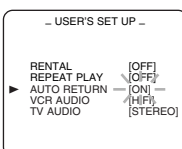

### 3 Auto Return will begin

When all the timer recordings are completed, the TV/VCR/DVD will rewind to the beginning of the recorded program(s).

#### NOTE:

- If you press the POWER button while tape is rewinding, the Auto Return will stop.

### 4 Watch the recorded program

Press the PLAY button.

## TO CANCEL THE AUTO RETURN MODE

Repeat steps [1] and [2], select [OFF] using the ENTER button.

**If there is a power failure of any kind, the TV/VCR/DVD will retain its memory for this feature.**

## SLEEP TIMER

### TV/VCR

The Sleep Timer function turns off the TV/VCR/DVD without using the POWER button after a desired period of time.

#### NOTE:

- This function does not operate during Recording mode.

### 1 Select "SLEEP TIMER"

Press the SLEEP button on the remote control until "SLEEP TIMER" appears.

### 2 Set sleep time

Press the SLEEP button until your desired sleep time appears.

Each additional push will increase the time by 30 minutes up to 120 minutes.

After 5 seconds, exit the Sleep Timer setting.

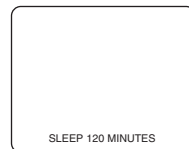

## TO CANCEL THE SLEEP TIMER

Press the SLEEP button on the remote control until "SLEEP TIMER" appears. Press the SLEEP button until "SLEEP 0 MINUTES" appears.

## ON SCREEN DISPLAY

To check the Counter, Clock and Channel number on the TV screen, press the DISPLAY button on the remote control. Each time you press the DISPLAY button on the remote control, the TV screen will change as follows:

### When the Closed Caption mode is OFF:

- Counter mode: After 5 seconds, only the counter remains. To clear it, press the DISPLAY button.
- Clock mode: After 5 seconds, only the clock and the channel number remain. To clear them, press the DISPLAY button.

### When the Closed Caption mode is ON:

- The On Screen Display disappear after 5 seconds.
- This is true even if the MUTE button is pressed, or the PAUSE button is pressed while recording.

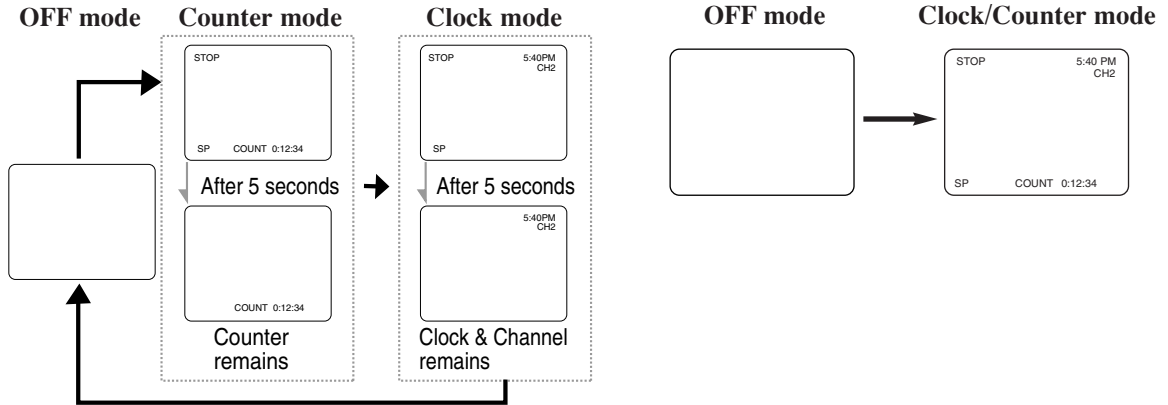

## CABLE CHANNEL DESIGNATIONS

If you subscribe to cable TV, the channels are displayed as 1-125. Cable companies often designate channels with letters or letter-number combinations. Please check with your local cable company. The following is a chart of common cable channel designations.

CATV channel	5A	2	3	4	5	6	7	8	9	10	11	12	13	A	B
TV Display	1	2	3	4	5	6	7	8	9	10	11	12	13	14	15
CATV channel	C	D	E	F	G	H	I	J	K	L	M	N	O	P	Q
TV Display	16	17	18	19	20	21	22	23	24	25	26	27	28	29	30
CATV channel	R	S	T	U	V	W	W+1	W+2	W+3	W+4	W+5	W+6	W+7	W+8	W+9
TV Display	31	32	33	34	35	36	37	38	39	40	41	42	43	44	45
CATV channel	W+10	W+11	W+12	W+13	W+14	W+15	W+16	W+17	W+18	W+19	W+20	W+21	W+22	W+23	W+24
TV Display	46	47	48	49	50	51	52	53	54	55	56	57	58	59	60
CATV channel	W+25	W+26	W+27	W+28	W+29	W+30	W+31	W+32	W+33	W+34	W+35	W+36	W+37	W+38	W+39
TV Display	61	62	63	64	65	66	67	68	69	70	71	72	73	74	75
CATV channel	W+40	W+41	W+42	W+43	W+44	W+45	W+46	W+47	W+48	W+49	W+50	W+51	W+52	W+53	W+54
TV Display	76	77	78	79	80	81	82	83	84	85	86	87	88	89	90
CATV channel	W+55	W+56	W+57	W+58	A-5	A-4	A-3	A-2	A-1	W+59	W+60	W+61	W+62	W+63	W+64
TV Display	91	92	93	94	95	96	97	98	99	100	101	102	103	104	105
CATV channel	W+65	W+66	W+67	W+68	W+69	W+70	W+71	W+72	W+73	W+74	W+75	W+76	W+77	W+78	W+79
TV Display	106	107	108	109	110	111	112	113	114	115	116	117	118	119	120
CATV channel	W+80	W+81	W+82	W+83	W+84										
TV Display	121	122	123	124	125										

## ABOUT THE DISCS

### PLAYABLE DISCS

The following discs can be played back on this TV/VCR/DVD.

- DVD video
- DVD-R/RW\*
- DVD+R/RW\*
- Audio CD
- CD-R/RW\*
- MP3\*

\* Depending on the types or the writing method of the medium some discs can not be played.

- Some DVD-R/RW, DVD+R/RW, or CD-R/RW discs made on personal computers, or on DVD recorders may not be played back properly due to the factors such as scratches, dirt or special properties of the disc.
- Discs made on personal computers may not be played back properly due to the different environment or the settings of the application you use. We recommend always to use the standardized, rightly formatted discs. (Please contact the sales agency for more detail).

This TV/VCR/DVD conforms to the NTSC color system. You cannot play discs recorded in other color systems such as PAL or SECAM.

- Some discs include region codes as shown below.



- The number inside the symbol refers to a region of the world, and a disc encoded in a specific region format can only be played back on TV/VCR/DVD with the same region code.

The following discs cannot be played back on this TV/VCR/DVD.

- DVD with region codes other than 1 or ALL.
- DVD-ROM
- DVD-RAM (Never play back, otherwise malfunction may result.)
- CD-ROM
- VSD
- CDV (Only plays back the audio part.)
- CD-G (Only plays back the sound.)
- CD-I (Never play back, otherwise malfunction may result.)
- SACD
- Photo CD (Never play back, otherwise malfunction may result.)
- Video CD (Never play back, otherwise malfunction may result.)

*Any other discs without compatibility indications.*

### DISC TYPES

#### [DVD]

Data on a DVD is divided into sections called "titles", and then into subsections called "chapters", each of which is given a title or chapter number. Playback conditions are preset on some DVD video discs, and these playback conditions take priority over user operations on this player. If a function you selected does not run as desired, refer to the manual accompanying the disc.

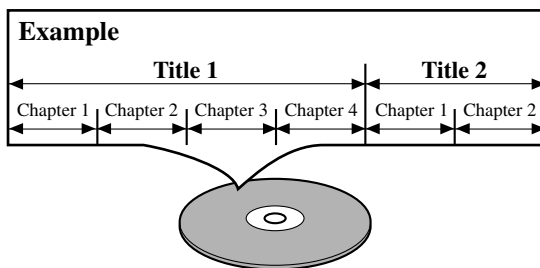

#### [AUDIO CD]

Data on an audio CD is divided into sections called "tracks", each of which is given a track number.

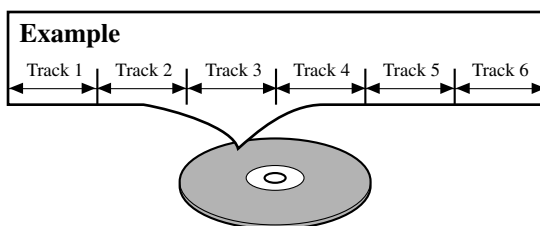

#### [MP3]

Data on an MP3 is divided into sections called "groups", and then into subsections called "tracks", each of which is given a group or track number.

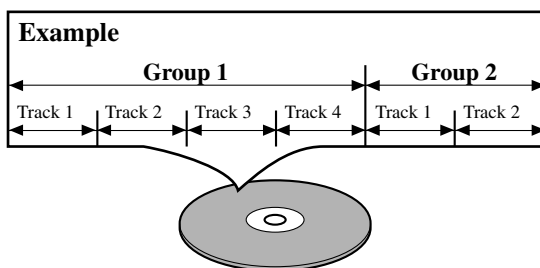

# PLAYING A DISC

## BASIC PLAYBACK

DVD-V CD

### Getting started

- Turn on the power of amplifier and any other components, if necessary.

1 Press the **POWER** button.

- The power will turn on.

2 Press the **OPEN/CLOSE** button to open disc loading tray.

3 Place the chosen disc in the tray, with the label facing up.

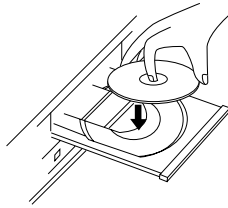

4 Press the **PLAY** button.

- The tray will close automatically, and playback will then start from the first chapter or track of the disc. If the playback does not start automatically, press the **PLAY** button.
- When you playback the DVD which a title menu is recorded, it may appear on the screen. In this case, refer to “TITLE MENU”.

5 Press the **STOP** button to stop playback.

### NOTES

- When the DVD mode has been switched to the TV/VCR mode, the DVD mode shuts down first and then TV picture and sound appears in about 4 seconds. Similarly, when the **POWER** button is pressed to turn off in the DVD mode, this mode shuts down first and then the TV/VCR/DVD’s power is turned off.
- A “prohibited icon” may appear at the top-right on the TV screen during operation, warning that a prohibited operation has been encountered by the DVD or the disc.
- With DVDs that use titles for playback program signals, playback may start from the second title, or it may skip these titles.
- During the playback of a two layered disc, pictures may stop for a moment. This happens when the 1st layer switches to the 2nd layer. This is not a malfunction.



## GENERAL FEATURES

DVD may contain menus to navigate the disc and access special features. Press the appropriate number buttons or use the Arrow buttons (▼/▲/◀/▶) to highlight your selection in the DVD main menu and press the **ENTER** button to confirm.

### NOTES

- Select DVD mode by pressing the **SELECT** button on the remote control. Then, operate the DVD functions.
- Unless stated, all operations described are based on remote control use. Some operations can be carried out using the menu bar on the TV screen.

## DISC MENU

DVD-V

1 Press the **DISC MENU** button.

- The DVD main menu will appear.

2 If the feature is not available,  symbol may appear on the TV screen.

3 If disc menu is available on the disc, audio language, subtitle options, chapters for the title and other options will appear for selection.

4 Press the Arrow buttons (▼/▲/◀/▶) to select an item, and the **ENTER** button to confirm selection.

## TITLE MENU

DVD-V

1 Press the **TITLE** button.

- The title menu will appear.

2 If the feature is not available,  symbol may appear on the TV screen.

3 Press the Arrow buttons (▼/▲/◀/▶) to select an item, and the **ENTER** button to confirm selection.

### CALLING UP A MENU SCREEN DURING PLAYBACK

#### For DVD-Vs

- Press the **DISC MENU** button to call up the DVD menu.
- Press the **TITLE** button to call up the title menu.

#### NOTE

- Contents of menus and corresponding menu operations may vary between discs. Refer to the manual accompanying the disc for details.

## RESUME

DVD-V CD

- 1 During playback, press the STOP button.
  - Resume message will appear on the TV screen.
- 2 Press the PLAY button, playback will resume from the point at which playback was stopped.
  - To cancel resume, press the STOP button twice.
  - If turn off the TV/VCR/DVD, resume function will be cancelled.

## PAUSE

DVD-V CD

- 1 During playback, press the PAUSE button.
  - Playback will pause and sound will be muted.
- 2 To continue playback, press the PLAY button.

## STEP BY STEP PLAYBACK

DVD-V

- 1 During playback, press the PAUSE button.
  - Playback will pause and sound will be muted.
- 2 The disc goes forward by one frame each time the PAUSE button is pressed.
- 3 To exit step by step playback, press the PLAY button.

## FAST FORWARD/REVERSE SEARCH

DVD-V CD MP3

- 1 During playback, press and hold down the F.FWD ►► or REV ◀◀ button for a few seconds.
- 2 Each press and hold down the F.FWD ►► or REV ◀◀ button repeatedly to select the required speed: x2, x8, x50, x100.
  - For audio CDs, the speed is fixed at ×16.
  - For MP3, the speed is fixed at ×8.
- 3 To return to normal playback, press the PLAY button.

### Note for using buttons on the main unit:

During playback, press and hold down the SKIP ►►/SEARCH ►► buttons or the SKIP ◀◀/SEARCH ◀◀ buttons on the TV/VCR/DVD for a few seconds to begin Search in x2 speed. Press and hold down again to change speed to x8. Repeat this procedure to change to x50 and x100.

## SLOW FORWARD / SLOW REVERSE

DVD-V

- 1 During playback, press the PAUSE button.
- 2 Press and hold down the F.FWD ►► or REV ◀◀ button for a few seconds.
- 3 Each press and hold down the F.FWD ►► or REV ◀◀ button repeatedly to select the required speed: 1/16, 1/8, 1/2 of the normal playback.
- 4 To return to normal playback, press the PLAY button.

### Note for using buttons on the main unit:

Press the PAUSE button, then, press and hold down the SKIP ►►/SEARCH ►► buttons or the SKIP ◀◀/SEARCH ◀◀ buttons on the TV/VCR/DVD for a few seconds to begin Search in 1/16 speed of the normal playback. Press and hold down again to change speed to 1/8. Repeat this procedure to change to 1/2.



# SEARCH FUNCTION

## TRACK SEARCH

CD

There are three ways to begin playback on an Audio CD at a specific Track.

### Using the Number buttons on the remote control

- 1 Press the Number buttons to enter the desired Track number.
  - Playback will start at the selected track.
  - For single digit tracks (1-9), press a single number (eg. track 3, press 3).
  - To play track 26, press +10, 2, 6.

### Using the SEARCH MODE button

- 1 Press the SEARCH MODE button.
  - The track search display appears.
- 2 Within 30 seconds, select a desired track number using the Number buttons on the remote control.
  - For single digits press 0 first.
  - Playback will start at the selected track.

### Using the SKIP |◀◀▶▶| buttons

During playback, press the SKIP ▶▶| button to move the next track. Press it repeatedly to skip subsequent tracks. Press the SKIP |◀◀ button to go back to beginning of the current track. Press it repeatedly to go to the previous tracks.

- If the SKIP button is pressed while the playback is paused, the playback will be paused again after skipping to the next track.

#### NOTE

- The SKIP |◀◀▶▶| buttons are not available when playback is stopped.

## TITLE / CHAPTER SEARCH

DVD-V

- 1 Press the SEARCH MODE button once for the Chapter search, twice for the Title search during playback.

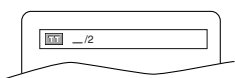

- 2 Enter the desired chapter/title number using the Number buttons on the remote control.
  - Playback will start at the selected Chapter or Track.
  - Press the CLEAR button to erase the incorrect input.
  - For single digits press 0 first.

## TIME SEARCH

DVD-V

CD

- 1 During playback, press the SEARCH MODE button three times (CD: twice) to display the Time Search on the TV screen.
- 2 Within 30 seconds, enter a desired disc time using the Number buttons on the remote control.
  - Playback will start at the specified time.
  - Press the CLEAR button to erase the incorrect input.

## MARKER SETUP SCREEN

DVD-V

CD

Use markers to memorise your favorite places on a disc.

- 1 Press the SEARCH MODE button four times (CD: three times) during playback.
  - The display screen and Markers will appear on the TV screen.
- 2 Press the Arrow buttons (◀/▶) to select 1, 2, 3, 4, 5, 6, 7, 8, 9, or 10 and ensure that “- : - - : -” appears in the display.
- 3 When reaches the desired point, press the ENTER button.
  - The Title or Track and elapsed playing time will appear in the TV screen.
- 4 To return to the Marker later, press the SEARCH MODE button four times (CD: three times) during playback and the Arrow buttons (◀/▶) to choose the desired marker, then press the ENTER button.

#### NOTES

- Opening the disc tray or turning off the power or select AC at step 2 and press the ENTER button will erase all Markers.
- To clear a marker, using the Arrow buttons (◀/▶), position the cursor on to the marker number to be cleared and press the CLEAR button.
- You can mark up to 10 points.

- 5 Press the SEARCH MODE or RETURN button to exit.



# SPECIAL PLAYBACK FUNCTION

## REPEAT

REPEAT is available only during playback.

### REPEAT TITLE / CHAPTER

DVD-V

To activate the repeat function, press the REPEAT button during playback.

- The repeat mode changes as described below every time you press the button.

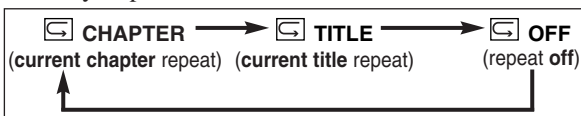

#### NOTES

- Repeat Title/Chapter is not available with some scenes.
- The REPEAT setting will be cleared when moving to other title or chapter.

### REPEAT TRACK

CD

To activate the repeat function, press the REPEAT button during playback.

- The repeat mode changes as described below every time you press the button.



#### NOTES

- Repeat setting will be cleared when moving to other track.
- Repeat playback does not function during repeat A-B playback.

### REPEAT A-B

DVD-V

CD

1 Press the REPEAT A-B button at your chosen starting point.

- A- appears briefly on the TV screen.

2 Press the REPEAT A-B button again at your chosen end point.

- A-B appears briefly on the TV screen, and the repeat sequence begins.

3 To exit the sequence, press the REPEAT A-B button.

#### NOTES

- The repeat A-B section can only be set within the current title (for DVDs), or current track (for audio CDs).
- Repeat A-B is not available with some scenes in DVD.
- To cancel the A point which was set, press the CLEAR button.
- Repeat A-B playback does not function during title, chapter, track or all repeat playback.

## PROGRAM

CD

You may determine the order in which tracks will play.

1 In stop mode, press the MODE button.

- The PROGRAM screen will appear.

2 Press the Arrow button or to select a track, then press the ENTER button.

- Press the CLEAR button to erase the most recently entered program.

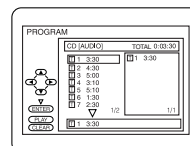

3 Repeat step 2 until you have selected all the tracks you want to play in the program.

4 Press the PLAY button to play the programmed tracks.

#### NOTES

- While the program is being played back, the STOP works as follows.
- Press the STOP button once and then the PLAY button again, playback will restart from the point where the STOP button was pressed. (Program continued)
- Press the STOP button twice and then the PLAY button again, playback will restart from the track in the usual way. (Program cleared)
- Up to 99 programs can be entered.
- If you like to repeat the current track in the program, press the REPEAT button repeatedly until TRACK appears during playback. If you like to repeat the entire program press the REPEAT button repeatedly until ALL appears during playback.

## RANDOM PLAYBACK

CD

This shuffles the playing order of tracks instead of playback in the sequence.

1 In stop mode, press the MODE button twice.

- RANDOM screen appears.

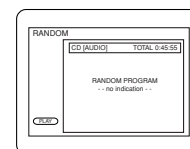

2 Press the PLAY button to start random playback.

#### NOTE

- If you like to repeat the current track in the random selection, press the REPEAT button repeatedly until TRACK appears during playback. If you like to repeat the entire random selection press the REPEAT button repeatedly until ALL appears during playback.

# PLAYING A MP3 DISC

## MP3 PLAYBACK

MP3

When a CD with MP3 files is in the TV/VCR/DVD, the MP3 menu will appear on the TV screen in stop mode.

### 1 In stop mode, press the Arrow buttons (▲/▼) to select the desired group track.

- If a group is selected, press the Arrow ► or ENTER button to go on to the track selection screen. Press the Arrow buttons (▲/▼) to choose a track, then press the ENTER button.
- If a track is selected, press the ENTER button to start playing tracks. Starting from the one you've just chosen the subsequent tracks will be played.
- Choose FIRST PLAY to start playback from the beginning of the listed tracks.
- Press the TITLE button to return to the first item.

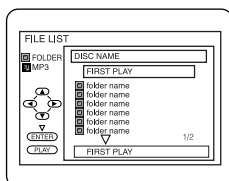

### 2 Press the STOP button to stop playback.

#### NOTES

- Folders are known as Groups; files are known as Tracks.
- MP3 files are accompanied by  icon.
- Maximum of 255 folders can be recognized.
- Maximum of 512 files can be recognized.
- Up to 8 hierarchies can be created.

This player recommends the use of files recorded at the below specifications:

- Sampling frequency: 44.1kHz or 48kHz
- Constant bit rate: 112kbps ~ 320kbps.

## TRACK SELECTION

MP3

### 1 Press the SEARCH MODE button during playback.

- The FILE LIST will appear.

### 2 Select a desired track using the Arrow buttons (▲/▼/◀/▶).

- Press the Arrow button ► when you want to go to the next hierarchy.
- Press the Arrow button ◀ when you want to go back to the previous hierarchy.

### 3 Press the PLAY button to start playback.

#### NOTES

- Press the SEARCH MODE button to exit.
- Some selections may take a while to be recognized.

## PROGRAM

MP3

This feature allows you to program an MP3 disc to play in a desired sequence.

### 1 In stop mode, press the MODE button.

- The PROGRAM screen will appear.

### 2 Select a desired track using the Arrow buttons (▲/▼/◀/▶). Then, press the ENTER button.

- Press the Arrow button ► when you want to go to the next hierarchy.
- Press the Arrow button ◀ when you want to go back to the previous hierarchy.
- Press the CLEAR button to erase the most recently entered program.

### 3 Repeat step 2 until you have selected all the Tracks you want to play in the program.

### 4 Press the PLAY button to start programmed playback.

## RANDOM PLAYBACK

MP3

### 1 In stop mode, press the MODE button twice.

- RANDOM screen appears.

### 2 Press the PLAY button to start random playback.

# CHANGING THE SETTINGS

## SUBTITLE LANGUAGE

DVD-V

The TV/VCR/DVD allows you to select a language for subtitles during DVD disc (if available) playback.

- 1 Press the **SUBTITLE** button during playback.
- 2 Press the **SUBTITLE** button repeatedly to select your desired subtitle language.
  - The subtitle language will appear on the display bar at the top of the TV screen.
- 3 To turn off subtitles, press the **SUBTITLE** button repeatedly until **OFF** appears.

### NOTES

- Some discs allow audio language setting/subtitle language setting on the disc menu. (Operation varies between discs, so refer to the manual accompanying the disc.)
- If the desired language is not shown after pressing the **SUBTITLE** button several times, the disc does not have subtitles in that language.
- If you choose a Language that has a 3 letter language code, the code will be displayed every time you change the Subtitle language setting. If you choose any other languages, '---' will be displayed instead. (Refer to page 44.)

## AUDIO LANGUAGE

DVD-V

The TV/VCR/DVD allows you to select a language during DVD disc (if multi language available) playback.

- 1 Press the **AUDIO** button during playback.
- 2 Press the **AUDIO** button repeatedly to select your desired language.

### NOTE

- Pressing the **AUDIO** button may not work on some DVDs with multiple audio languages (e.g. DVDs which allow audio language setting on the disc menu).

## STEREO SOUND MODE

CD

- 1 Press the **AUDIO** button repeatedly during playback to select between **STEREO**, **L-CH** or **R-CH**.
  - **STEREO** - both right and left channels are active (stereo)
  - **L-CH** - only left channel is active
  - **R-CH** - only right channel is active

### NOTE

- If the Virtual Surround setting is **ON**, the sound mode will be fixed to **STEREO**, and can not be changed.

## CAMERA ANGLE

DVD-V

Some DVD discs contain scenes which have been shot simultaneously from various angles. You can change the camera angle when the (  ) icon appears on the screen.

- 1 Press the **ANGLE** button during playback.
  - The selected angle will be displayed on the display bar at the top of the screen.
- 2 Press the **ANGLE** button repeatedly to select your desired angle.

## BLACK LEVEL SETTING

DVD-V

Adjust the Black Level Settings to make the black parts of the picture brighter.

- 1 Press the **MODE** button during playback.

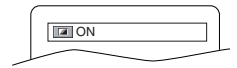

- 2 Press the **ENTER** button to switch **OFF**.  
**ON**: Makes the dark parts brighter.  
**OFF**: Shows the original picture as recorded.

- 3 Press the **MODE** button twice or the **RETURN** button to exit.

## VIRTUAL SURROUND

DVD-V

CD

MP3

You can enjoy stereophonic visual space on your existing stereo system.

- 1 Press the **V.SURR** button once or **MODE** button twice (CD/MP3: once) during playback.
- 2 Press the **ENTER** button to set it 1 (Natural effect) or 2 (Emphasized effect) or **OFF**.
- 3 Press the **V. SURR** or **RETURN** button to exit.

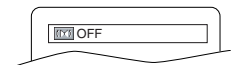

### NOTE (for CD play only)

- Virtual Surround will not be effective if the sound mode is set to something other than **STEREO**.

# THE ON-SCREEN INFORMATION

DVD-V CD MP3

You can check the information about the current disc by pressing the DISPLAY button on the remote control.

## For DVD-Vs

1 Press the DISPLAY button during playback to show current Chapter.

- The elapsed and remaining playing time of the current chapter will be displayed.

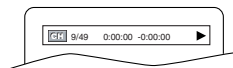

2 Press the DISPLAY button again to show current Title.

- The elapsed and remaining playing time of the current title will be displayed.

3 Press the DISPLAY button again.

- The BIT RATE and the current repeat setting will be displayed.
- If you are playing a dual layered disc, the layer number will also be displayed (L0: Layer 0 is playing. L1: Layer 1 is playing).

4 Press the DISPLAY button again to exit the display.

## For audio CDs

1 Press the DISPLAY button during playback to show the current Track.

- The elapsed and remaining playing time of the current track will be displayed.

2 Press the DISPLAY button again to show current Total Track.

- The elapsed and remaining playing time of the current total track will be displayed.

3 Press the DISPLAY button again to exit the display.

## For MP3

1 Press the DISPLAY button during playback.

- The name of the file currently in play will be displayed.

2 Press the DISPLAY button repeatedly to show the track number, the repeat status, and the playback status at the top of the screen.

-  will be displayed when repeat play has been selected.

 T - indicates Track repeat

 G - indicates Group (folder) repeat

 A - indicates Disc repeat

3 Press the DISPLAY button again to exit the display.

# CHANGING THE DVD SETUP ITEMS

## LANGUAGE SETTING

**DVD-V**

Language options are not available with some discs.

**1** Press the **SETUP** button twice in **STOP** mode so that the **DVD SETUP** menu appears.

- If the menu does not appear, press the **PLAY** button, the **STOP** button, then the **SETUP** button twice.

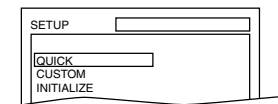

**2** Press the **Arrow** button **▼** to select **CUSTOM**, then press the **ENTER** button.

- **CUSTOM** mode will appear.

**3** Press the **Arrow** buttons (**▲/▼**) to select "**LANGUAGE**", then press the **ENTER** button to confirm.

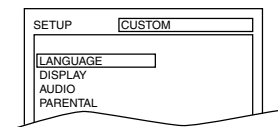

**4** Press the **Arrow** buttons (**▲/▼**) to select the next items, then press the **ENTER** button.

**AUDIO:**

- Sets the audio language.

**SUBTITLE:**

- Sets the subtitle language.

**DISC MENU:**

- Sets the language for DVD menu.

**5** Press the **Arrow** buttons (**▲/▼**) to select a setting, then press the **ENTER** button.

- If **OTHER** is selected on the **AUDIO**, **SUBTITLE** or **DISC MENU** screen, press four-digit number to enter the code for the desired language. (Refer to the language code list.)
- Only the languages supported by the disc can be selected.

**6** Press the **SETUP** button to exit.

**NOTE**

- Language Setting for Audio and Subtitle is not available with some discs. Then use the **AUDIO** and the **SUBTITLE** buttons. Details are on page 42.

### TO CHANGE THE ON-SCREEN MENUS

You can access the TV/VCR **SETUP** menu by pressing the **SETUP** button from the **DVD** mode. Refer to "SELECTING THE LANGUAGE" on page 15 to changing the on-screen menus.

Language	Code	Language	Code
<b>A-B</b>		<b>L-N</b>	
Abkhazian	4748	Laothian	5861
Afar	4747	Latin	5847
Afrikaans	4752	Latvian;Lettish	5868
Albanian	6563	Lingala	5860
Amharic	4759	Lithuanian	5866
Arabic	4764	Macedonian	5957
Armenian	5471	Malagasy	5953
Assamese	4765	Malay	5965
Aymara	4771	Malayalam	5958
Azerbaijani	4772	Maltese	5966
Bashkir	4847	Maori	5955
Basque	5167	Marathi	5964
Bengali;Bangla	4860	Moldavian	5961
Bhutani	5072	Mongolian	5960
Bihari	4854	Nauru	6047
Bislama	4855	Nepali	6051
Breton	4864	Norwegian [NOR]	6061
Bulgarian	4853	<b>O-R</b>	
Burmese	5971	Occitan	6149
Byelorussian	4851	Oriya	6164
<b>C-E</b>		Oromo(Afan)	6159
Cambodian	5759	Panjabi	6247
Catalan	4947	Pashto;Pushto	6265
Chinese [CHI]	7254	Persian	5247
Corsican	4961	Polish	6258
Croatian	5464	Portuguese [POR]	6266
Czech	4965	Quechua	6367
Danish [DAN]	5047	Rhaeto-Romance	6459
Dutch [DUT]	6058	Romanian [RUM]	6461
English [ENG]	5160	Russian [RUS]	6467
Esperanto	5161	<b>S</b>	
Estonian	5166	Samoan	6559
<b>F-H</b>		Sangho	6553
Faroese	5261	Sanskrit	6547
Fiji	5256	Scots Gaelic	5350
Finnish [FIN]	5255	Serbian	6564
French [FRE]	5264	Serbo-Croatian	6554
Frisian	5271	Sesotho	6566
Galician	5358	Setswana	6660
Georgian	5747	Shona	6560
German [GER]	5051	Sindhi	6550
Greek [GRE]	5158	Singhalese	6555
Greenlandic	5758	Siswat	6565
Guarani	5360	Slovak	6557
Gujarati	5367	Slovenian	6558
Hausa	5447	Somali	6561
Hebrew	5569	Spanish [SPA]	5165
Hindi	5455	Sundanese	6567
Hungarian [HUN]	5467	Swahili	6569
<b>I-K</b>		Swedish [SWE]	6568
Icelandic [ICE]	5565	<b>T</b>	
Indonesian	5560	Tagalog	6658
Interlingua	5547	Tajik	6653
Interlingue	5551	Tamil	6647
Inupiak	5557	Tatar	6666
Irish [IRI]	5347	Telugu	6651
Italian [ITA]	5566	Thai	6654
Japanese [JPN]	5647	Tibetan	4861
Javanese	5669	Tigrinya	6655
Kannada	5760	Tonga	6661
Kashmiri	5765	Tsonga	6665
Kazakh	5757	Turkish [TUR]	6664
Kinyarwanda	6469	Turkmen	6657
Kirghiz	5771	Twi	6669
Kirundi	6460	<b>U-Z</b>	
Korean [KOR]	5761	Ukrainian	6757
Kurdish	5767	Urdu	6764
		Uzbek	6772
		Vietnamese	6855
		Volapuk	6861
		Welsh	4971
		Wolof	6961
		Xhosa	7054
		Yiddish	5655
		Yoruba	7161
		Zulu	7267

If you choose a Language that has a 3 letter language code, the code will be displayed every time you change the Audio or Subtitle language setting on page 42. If you choose any other languages, '---' will be displayed instead. (3 letter language code is written in bracket.)

## DISPLAY SETTING

### DVD-V

You can change certain aspects of the DVD display screens and on-screen messages on the TV screen.

1 Press the **SETUP** button twice in **STOP** mode so that the **DVD SETUP** menu appears.

- If the menu does not appear, press the **PLAY** button, the **STOP** button, then the **SETUP** button twice.

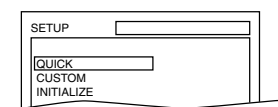

2 Press the **Arrow** button **▼** to select **CUSTOM**, then press the **ENTER** button.

- **CUSTOM** mode will appear.

3 Press the **Arrow** buttons (**▲/▼**) to select **"DISPLAY"**, then press the **ENTER** button to confirm.

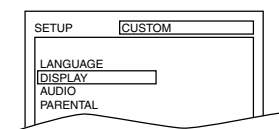

4 Press the **Arrow** buttons (**▲/▼**) to select the below items, then press the **ENTER** button.

### TV MODE: **QUICK**

- Press the **Arrow** buttons (**▲/▼**) for an item selection, then press the **ENTER** button.
- Select **4:3 LETTER BOX** for a black bars appears on top and bottom of the screen.
- Select **4:3 PAN & SCAN** for a full height picture with both sides trimmed.
- The default setting is **4:3 LETTER BOX**.

### STILL MODE:

- Press the **Arrow** buttons (**▲/▼**) for an item selection, then press the **ENTER** button.
- Select **"AUTO"** usually.
- If you select **"FIELD"**, the picture in the still mode will be stabilized.
- If you select **"FRAME"**, the picture in the still mode will be highly defined.

### ANGLE ICON:

- Press the **ENTER** button repeatedly to turn Angle icon **ON** or **OFF**.
- The default setting is **ON**.

### AUTO POWER OFF:

- Press the **ENTER** button repeatedly to turn Auto Power off **ON** or **OFF**.
- The default setting is **ON** and it will turn the TV/VCR/DVD to off automatically after 15 minutes of no use.

5 Press the **SETUP** button to exit.

## AUDIO SETTINGS

Choose the appropriate Audio settings for your equipment as it only affect during the playback of DVD discs.

1 Press the **SETUP** button twice in **STOP** mode so that the **DVD SETUP** menu appears.

- If the menu does not appear, press the **PLAY** button, the **STOP** button, then the **SETUP** button twice.

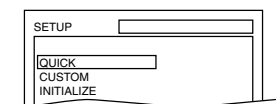

2 Press the **Arrow** button **▼** to select **"CUSTOM"**, then press the **ENTER** button.

- **CUSTOM** mode will appear.

3 Press the **Arrow** buttons (**▲/▼**) to select **"AUDIO"**, then press the **ENTER** button to confirm.

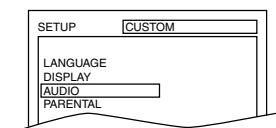

4 Press the **Arrow** buttons (**▲/▼**) to select the below items, then press the **ENTER** buttons.

### DRC (Dynamic Range Control):

- To compress the range of soft to loud sound.
- The default setting is **OFF**.

### DOWN SAMPLING:

- Set to **ON** when outputting in 48 kHz.
- The default setting is **ON**.

### When playing disc with copyright Protection

- If you select **OFF**, copyright protection will be activated and sound will be down sampled at 48kHz.

### DOLBY DIGITAL: **QUICK**

Set to **On** when the unit is connected to a Dolby Digital Decoder.

(**ON**: Output a Dolby Digital signal)

(**OFF**: Convert the Dolby Digital to PCM (2 channel stereo))

- The default setting is **ON**.

5 Press the **SETUP** button to exit.



# PARENTAL CONTROL

## DVD-V

Parental Control limits the disc viewing that exceed your settings. (with a password or playback will stop.) This feature allows you to prevent discs with alternative scenes from being played by your children.

### PARENTAL LEVEL

Parental Level allows you to set the rating level of your DVD discs. Playback will stop if the disc's ratings exceed the level you set.

**1** Press the **SETUP** button twice in **STOP** mode so that the **QUICK SETUP** menu appears.

- If the menu does not appear, press the **PLAY** button, the **STOP** button, then the **SETUP** button twice.

**2** Press the **Arrow** button **▼** to select "**CUSTOM**", then press the **ENTER** button.

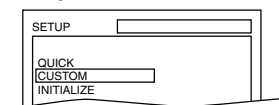

**3** Press the **Arrow** buttons (**▲/▼**) to select "**PARENTAL**", then press the **ENTER** button.

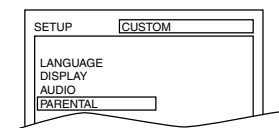

**4** Enter your four-digit password then press the **ENTER** button.

**5** Press the **Arrow** buttons (**▲/▼**) to select "**PARENTAL LEVEL**", then press the **ENTER** button.

**6** Press the **Arrow** buttons (**▲/▼**) to select the desired level, then press the **ENTER** button.

**7** Press the **SETUP** button to exit

### NOTES

- When doing this for the first time, enter any 4 digits. (except for 4737) That number will be used as the password. (in the event you forget the password, see below)
- To change the password, press the **Arrow** buttons (**▲/▼**) to select **CHANGE** at step 5, then press the **ENTER** button. Enter the four-digit password, then press the **ENTER** button.
- With some DVDs, it may be difficult to find if they are compatible with parental lock. Be sure to check if the parental lock function operates in the way that you have set.
- Record the password in case you forget it.

### CONTROL LEVELS

#### • ALL

All parental lock is cancelled.

#### • Level 8

DVD software of any grade (adult/general/children) can be played back.

#### • Levels 7 to 2

Only DVD software intended for general use and children can be played back.

#### • Level 1

Only DVD software intended for children can be played back, with those intended for adult and general use prohibited.

### IF YOU FORGET THE PASSWORD

**1** Press the number buttons **4, 7, 3, 7** at step 4. Then enter your new password.

- Password will be cleared and parental level will be set to **ALL**.

**2** Proceed the Steps 5-7 again.



## TROUBLESHOOTING GUIDE

If the TV/VCR/DVD does not perform properly when operated as instructed in this Owner's Manual, check the player, consulting the following checklist.

PROBLEM	CORRECTIVE ACTION
No power	<ul style="list-style-type: none"> <li>• Make sure the power plug is connected to an AC outlet.</li> <li>• Make sure the power is turned on.</li> </ul>
The TV/VCR/DVD does not respond to the remote control	<ul style="list-style-type: none"> <li>• Check if the power plug is connected to an AC outlet.</li> <li>• Check the batteries in the remote control.</li> <li>• Aim the remote control directly at the remote sensor. If necessary, remove all the obstacles between the sensor and the remote.</li> <li>• You have to be within 23 feet of the TV/VCR/DVD.</li> <li>• Check if the correct mode is selected. If not switch the mode by pressing the SELECT button on the remote control, whichever you need.</li> </ul>

### TV/VCR Mode

Sometimes a performance problem can be easily solved by checking seemingly apparent but often overlooked possibilities. Before arranging for service, check these items. It could save your time and money.

PROBLEM	CORRECTIVE ACTION
No picture and sound	<ul style="list-style-type: none"> <li>• Make sure the AC cord is connected to an AC outlet.</li> <li>• Check antenna connection.</li> <li>• Press the SELECT button on the remote control to select TV mode. Then try other TV feature.</li> <li>• Let the TV/VCR/DVD program its tuner memory.</li> </ul>
No picture or poor picture on TV/VCR/DVD	<ul style="list-style-type: none"> <li>• Adjust direction or replace antenna.</li> <li>• Adjust picture controls.</li> </ul>
No sound or poor sound	<ul style="list-style-type: none"> <li>• Adjust volume control on remote control or main unit.</li> <li>• Press the MUTE button to restore sound.</li> </ul>
Bars On Screen	<ul style="list-style-type: none"> <li>• If outside antenna is being used, check for broken wire.</li> <li>• Check for local interference.</li> </ul>
Picture Distorted or Blurred	<ul style="list-style-type: none"> <li>• Try a new channel, if OK, then possible station trouble.</li> <li>• If outside antenna is being used, check for broken wire.</li> </ul>
Picture Rolls Vertically Lines or Streaks in Picture	<ul style="list-style-type: none"> <li>• Try a new channel, if OK, then possible station trouble.</li> <li>• If outside antenna is being used, check for broken wire.</li> <li>• Check for local interference.</li> </ul>
No Color	<ul style="list-style-type: none"> <li>• Try a new channel, if OK, then possible station trouble.</li> <li>• Is antenna connected to terminal on the back of the set?</li> <li>• If outside antenna is being used, check for broken wire.</li> <li>• Adjust COLOR control.</li> </ul>
Poor Reception on Some Channels Ghosts in Picture	<ul style="list-style-type: none"> <li>• Try a new channel, if OK, then possible station trouble.</li> <li>• Is antenna connected to terminal on the back of the set?</li> <li>• If outside antenna is being used, check for broken wire.</li> <li>• Check for local interference.</li> </ul>
Weak Picture	<ul style="list-style-type: none"> <li>• Try a new channel, if OK, then possible station trouble.</li> <li>• Is antenna connected to terminal on the back of the set?</li> <li>• If outside antenna is being used, check for broken wire.</li> <li>• Adjust CONTRAST &amp; BRIGHT control.</li> </ul>
Sound OK, Picture Poor	<ul style="list-style-type: none"> <li>• Try a new channel, if OK, then possible station trouble.</li> <li>• Is antenna connected to terminal on the back of the set?</li> <li>• If outside antenna is being used, check for broken wire.</li> <li>• Check for local interference.</li> <li>• Adjust CONTRAST &amp; BRIGHT control.</li> </ul>

<b>PROBLEM</b>	<b>CORRECTIVE ACTION</b>
Picture OK, Sound Poor  Timer recording is not possible	<ul style="list-style-type: none"> <li>• Try a new channel, if OK, then possible station trouble.</li> <li>• Check for local interference.</li> <li>• Make sure the timer recording is set correctly.</li> <li>• Make sure the power is off.</li> <li>• Make sure the TV/VCR/DVD clock is set correctly.</li> </ul>
Cannot go into Record mode	<ul style="list-style-type: none"> <li>• Make sure the tape has an erase-prevention tab. If need, cover the hole with plastic tape.</li> </ul>
Playback picture is partially noisy	<ul style="list-style-type: none"> <li>• Adjust tracking control for a better picture using the CHANNEL button ▲ or ▼ on the TV/VCR/DVD.</li> </ul>
No picture but the audio is OK in playback	<ul style="list-style-type: none"> <li>• Head cleaning may be necessary. Refer to “AUTO HEAD CLEANING” on page 50.</li> </ul>
No operation by infrared Remote Control	<ul style="list-style-type: none"> <li>• Make sure the AC cord is connected to an AC outlet.</li> <li>• Check batteries in remote control.</li> </ul>
Video or color fades in and out when making a copy of a video tape	<ul style="list-style-type: none"> <li>• You can not copy a copyrighted video tape. You are experiencing copy guard protection.</li> </ul>
Different color marks on screen	<ul style="list-style-type: none"> <li>• Magnetism from nearby appliances and geomagnetism might affect the color of the TV picture. Move the TV/VCR/DVD away from the appliances, the TV/VCR/DVD can repair itself automatically. If you want to repair immediately, unplug the power cord, then plug it in again 30 minutes later or so.</li> </ul>

<b>CLOSED CAPTION PROBLEM</b>	<b>POSSIBLE REMEDY</b>
My TV/VCR/DVD is showing captions that are misspelled.	<ul style="list-style-type: none"> <li>• You are watching a live broadcast and spelling errors made by the closed captioning production company may pass through uncorrected. A prerecorded program will not show any misspelled words because of the normal time available for editing the captions.</li> </ul>
My TV/VCR/DVD will not show the text dialogue in its entirety or there is a delay of what is being said.	<ul style="list-style-type: none"> <li>• Captions that are delayed a few seconds behind the actual are common for live broadcast. Most captioning production companies can display a dialogue to a maximum of 220 words per minute. If a dialogue exceeds that rate, selective editing is used to insure that the captions remain up-to-date with the current TV screen dialogue.</li> </ul>
My captions are scrambled with white boxes on the TV screen.	<ul style="list-style-type: none"> <li>• Interference caused by building, power lines, thunderstorms, etc. may cause scrambled or incomplete captions to appear.</li> </ul>
My program guide listed a TV show as being closed captioned but none of the captions were displayed.	<ul style="list-style-type: none"> <li>• Broadcasters may at times use a time compression process to speed up the actual program so that additional advertising time can be given. Since the decoder cannot read the compressed information, captions will be lost.</li> </ul>
My prerecorded video tape does not show any captions. The tape box mentions it being closed captioned.	<ul style="list-style-type: none"> <li>• The video tape was either an illegal copy or the tape duplicating company accidentally left out the captioning signals during the copying process.</li> </ul>
My TV screen shows a black box on certain channels.	<ul style="list-style-type: none"> <li>• You are in the TEXT mode. Select CAPTION mode to CAPTION [OFF].</li> </ul>

**DVD Mode**

<b>PROBLEM</b>	<b>CORRECTIVE ACTION</b>
No picture	<ul style="list-style-type: none"><li>• Connect the video cables firmly.</li><li>• Insert a correct video disc that plays on this TV/VCR/DVD.</li><li>• Press the SELECT button on the remote control to select DVD mode. Then, try other DVD feature.</li></ul>
Disc cannot be played	<ul style="list-style-type: none"><li>• Insert the disc.</li><li>• Clean the disc.</li><li>• Place the disc correctly, with the label side up.</li><li>• Cancel the parental lock or change the control level.</li></ul>
No sound	<ul style="list-style-type: none"><li>• Connect the audio cables firmly.</li><li>• Turn the power of the audio component on.</li><li>• Correct the audio output settings.</li><li>• Correct the input settings on the audio component.</li></ul>
No DTS audio is output	<ul style="list-style-type: none"><li>• This TV/VCR/DVD does not support DTS audio. This is not a malfunction.</li></ul>
Distorted picture	<ul style="list-style-type: none"><li>• There are some cases where pictures may be slightly distorted, which are not a sign of a malfunction.</li><li>• Although pictures may stop for a moment, this is not a malfunction.</li></ul>
Audio or subtitle language does not match the set up	<ul style="list-style-type: none"><li>• The selected language is not available for audio or subtitles on the DVD. This is not a malfunction</li></ul>
The camera angle cannot be changed	<ul style="list-style-type: none"><li>• The DVD does not contain sequences recorded from different camera angles. This is not a malfunction</li></ul>
Audio or subtitle language cannot be changed	<ul style="list-style-type: none"><li>• The DVD does not contain audio source or subtitles in the selected language. This is not a malfunction.</li></ul>
“Prohibited icon” appears on the screen, prohibiting an operation	<ul style="list-style-type: none"><li>• That operation is prohibited by the player or the disc. This is not a malfunction.</li></ul>
CD sound dropout No CD reproduction DVD picture dropout DVD picture freeze DVD picture in mosaic No DVD reproduction	<ul style="list-style-type: none"><li>• Scratched disc. Replace the disc with unscratched one.</li></ul>

**NOTES:**

- Some functions are not available in specific modes, but this is not a malfunction. Read the description in this Owner’s Manual for details on correct operations.
- Playback from a desired track and random playback are not available during program playback.

# MAINTENANCE

## CABINET CLEANING

- Wipe the front panel and other exterior surfaces of the TV/VCR/DVD with a soft cloth immersed in lukewarm water and wrung dry.
- Never use a solvent or alcohol. Do not spray insecticide liquid near the TV/VCR/DVD. Such chemicals may cause damage and discoloration to the exposed surfaces.

## AUTO HEAD CLEANING

- Automatically cleans video heads as you insert or remove a cassette, so you can see a clear picture.
- Playback picture may become blurred or interrupted while the TV program reception is clear. Dirt accumulated on the video heads after long periods of use, or the usage of rental or worn tapes can cause this problem.

If a streaky or snowy picture appears during playback, the video heads in your TV/VCR/DVD may need to be cleaned.

## IF THE LASER OPTICAL PICKUP UNIT IS DIRTY

- If the TV/VCR/DVD still does not perform properly when it is operated while referring to the relevant sections and to "TROUBLESHOOTING GUIDE" in this Owner's Manual, the laser optical pickup unit may be dirty. Consult your dealer or an Authorized Service Center for inspection and cleaning of the laser optical pickup unit.

1. Please visit your local Audio/Video store and purchase a good quality VHS Video Head Cleaner.
2. If a Video Head Cleaner does not solve the problem, please call our help line at 1-800-968-3429, to locate an Authorized Service Center.

### NOTES:

- Remember to read the instructions included with the video head cleaner before use.
- Clean video heads only when problems occur.

## SERVICING

- Should your TV/VCR/DVD become inoperative, do not try to correct the problem by yourself. There are no user-serviceable parts inside. Turn off, unplug the power cord, and please call our help line at 1-800-968-3429, to locate an Authorized Service Center.

## DISC HANDLING

- Use discs which have the following logos on them. (Optical audio digital discs.)



- Handle the discs so that fingerprints and dust do not adhere to the surfaces of the discs.

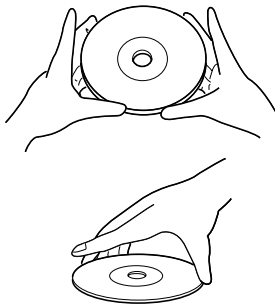

- Always store the disc in its protective case when it is not used.

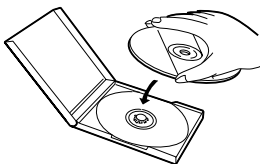

- To clean-off, use a soft cloth.
- Do not use a hard cloth since this will mar the disc.
- Wipe the disc in a straight line from center to edge.
- Never wipe with a circular motion.
- Do not use detergent or abrasive cleaning agents.

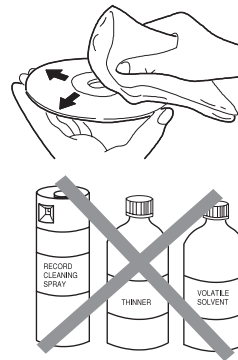

# SPECIFICATIONS

## GENERAL SPECIFICATIONS

### TV/VCR

CRT	20 inch in-line gun, 90° deflection tube
Television system :	NTSC-M
Closed caption system :	§15.119/FCC
Video Heads :	Rotary four-head
Tape width :	1/2 inch
Tape speed	
SP :	33.40mm/sec.
LP :	16.67mm/sec.
SLP :	11.12mm/sec.
Tuner channel	
TV VHF Low :	#2~#6
TV VHF High :	#7~#13
TV UHF :	#14~#69
CATV	
VHF :	5A
MID band :	A5~A1, A~I
SUPER band :	J~W
HYPER band :	W+1~W+84

### DVD

Product type:	DVD Player
Discs:	DVD video, Audio CD
Output signal format:	NTSC color
Frequency response (out put jack)	
DVD (linear sound):	20 Hz to 22 kHz (sample rate: 48 kHz)
CD:	20 Hz to 44 kHz (sample rate: 96 kHz)
CD:	20 Hz to 20 kHz
Signal-to-noise ratio (S/N ratio)(out put jack)	
CD:	75 dB (EIAJ)
Dynamic range (out put jack)	
DVD (linear sound):	85 dB
CD:	84 dB (EIAJ)
Total distortion factor	
CD:	0.07% (EIAJ)
Wow and flutter:	Below the measurement limitation (+/-0.001% W PEAK) (EIAJ)

## ELECTRICAL SPECIFICATIONS

Sound output: 2 speakers, 1W, 8 ohm

## OTHER SPECIFICATIONS

Terminals	
Antenna input:	VHF/UHF/CATV 75 ohm unbalanced (F-type)
Video input:	RCA connector × 1
Audio L/R input:	RCA connector × 2
Headphone:	1/8" stereo (3.5 mm)
Coaxial digital audio output:	One pin jack, 500m Vpp (75 ohm)
Remote control:	Digital encoded infrared light system
Operating temperature:	5°C to 40°C (41°F~104°F)
Power requirements:	AC 120V, 60Hz
Power consumption (Maximum):	90W
Picture tube:	20"
Dimensions:	H:20-3/16" (512.5mm) W:22-1/8" (562.0mm) D:19-8/7" (504.5mm)
Weight:	50.7 lbs (23.0kg)

- Designs and specifications are subject to change without notice.
- If there is a discrepancy between languages, the default language will be English.

# INDICE

■ <b>CONTROLES DE OPERACIÓN Y FUNCIONES</b> . . . . .	52
PANEL FRONTAL DEL TELEVISOR/DVD. . . . .	52
MANDO A DISTANCIA . . . . .	52
VISTA POSTERIOR . . . . .	52
■ <b>PREPARACIÓN PARA LA UTILIZACIÓN</b> . . . . .	53
CONEXIONES DE ANTENA/CABLE . . . . .	53
CONEXIÓN A TOMAS DE ENTRADA EXTERNA. . . . .	53
PARA INSERTAR LAS PILAS . . . . .	54
MODO DE ENTRADA EXTERNA . . . . .	54
CONEXIÓN A UN SISTEMA ESTÉREO . . . . .	54
CONEXIÓN A UN AMPLIFICADOR ESTÉREO EQUIPADO CON TOMAS DE ENTRADA DIGITAL, PLATINA MD O PLATINA DAT (Para DVD). . . . .	54
CONEXIÓN A UN DECODIFICADOR DOLBY DIGITAL (para DVD) . . . . .	54
<b>SECCIÓN DE TV/VCR</b>	
■ <b>PREPARACIÓN PARA LA UTILIZACIÓN</b> . . . . .	54
SELECCIÓN DE IDIOMA . . . . .	54
AJUSTE DE CANALES . . . . .	55
AJUSTE DEL RELOJ . . . . .	55
<b>SECCIÓN DE DVD</b>	
REPRODUCCIÓN BÁSICA . . . . .	55

## CONTROLES DE OPERACIÓN Y FUNCIONES

### PANEL FRONTAL DEL TELEVISOR/DVD

Consulte la figura 1 de la página 9

### MANDO A DISTANCIA

Consulte la figura 2 de la página 9

### VISTA POSTERIOR

Consulte la figura 3 de la página 10

- 1. Botón POWER**  
Presione este botón para conectar y desconectar la alimentación.
- 2. Botones VOLUME ▲/▼**  
Presione estos botones para controlar el nivel de volumen del DVD y el televisor.
- 3. Botones SKIP (para DVD)**  
Presione el botón correspondiente una vez para omitir capítulos o pistas y desplazarse a un punto específico. Mantenga el botón presionado para cambiar la velocidad de reproducción en avance o retroceso.
- 4. Botón PLAY**  
Inicia la reproducción del contenido del disco o cinta.
- 5. Botón STOP**  
Detiene la reproducción del disco.
- 6. Botón OPEN/CLOSE**  
Presione este botón para insertar discos en la bandeja o retirarlos de ella.
- 7. Bandeja de carga del disco**
- 8. Indicador DVD**  
Se ilumina durante el modo DVD.
- 9. Botón SELECT**  
Presione este botón para cambiar al modo TV/VCR, modo de entrada externa o modo de DVD.
- 10. Indicador TV/VCR**  
Se ilumina durante el modo TV/VCR.
- 11. Botones CHANNEL ▲/▼**  
Utilice estos botones para seleccionar canales memorizados.

- 12. Indicador de grabación**  
Parpadea durante la grabación. Se ilumina durante el modo de espera de grabación controlada por temporizador.
- 13. Botón REC/OTR (RECORD)**  
Presione este botón para grabar manualmente. Este botón también activa la función de grabación instantánea (OTR). (La función OTR sólo está disponible durante el modo TV/VCR.)
- 14. Botón REW (para TV/VCR)**  
Presione este botón para rebobinar la cinta o para ver la imagen rápidamente en dirección de retroceso durante el modo de reproducción. (Búsqueda en dirección de retroceso)
- 15. Botón F.FWD (para TV/VCR)**  
Presione este botón para adelantar rápidamente la cinta o para ver la imagen rápidamente en dirección de avance durante el modo de reproducción. (Búsqueda en dirección de avance)
- 16. Botón STOP/EJECT**  
Presione este botón para detener la cinta. Presiónelo en el modo de parada para retirar la cinta del televisor/DVD/videograbadora.
- 17. Ventanilla del sensor de mando a distancia**
- 18. Toma HEADPHONE**  
Para conectar auriculares (no suministrados) y escuchar en privado.
- 19. Toma de entrada VIDEO**  
Conecte aquí la toma de salida de vídeo de una videocámara o de una videograbadora.
- 20. Tomas de entrada AUDIO L/R**  
Conecte aquí las tomas de salida de audio de una videocámara o de una videograbadora.
- 21. Compartimiento del cassette**
- 22. Botón PICTURE**  
Presione este botón para ajustar la imagen.
- 23. Botones numéricos**  
**Modo TV:**  
Presione dos botones para acceder directamente al canal deseado.  
No olvide presionar "0" antes de elegir un canal de un solo dígito.  
**Botón +100**  
Presione este botón para seleccionar canales de televisión por cable cuyo número sea igual o superior a 100.  
**Modo DVD:**  
Presione este botón para introducir el número deseado.  
**Botón +10**  
Presione este botón para introducir números iguales o mayores que 10.
- 24. Botón PAUSE**  
Hace una pausa en la reproducción del disco o cinta.
- 25. Botón SPEED**  
Presione este botón para seleccionar la velocidad de grabación deseada: SP/SLP.
- 26. Botón C.RESET**  
Presione este botón para poner el contador en 0:00:00. Presiónelo también para cancelar un ajuste de programa de temporizador.
- 27. Botón DISPLAY**  
**Modo TV/VCR:**  
Para visualizar el contador o el número del canal y la fecha actual en la pantalla del televisor.  
**Modo DVD:**  
Indica el estado actual en la pantalla del televisor para fines de comprobación.
- 28. Botón SETUP**  
Presione este botón para activar o salir del modo de menús de televisor o configuración de DVD.
- 29. Botón TITLE**  
Para visualizar el menú de títulos.



- 30. Botón CLEAR**  
Para cancelar ajustes.
- 31. Botón MODE**  
Activa el modo de reproducción programada o el modo de reproducción aleatoria.
- 32. Botón SEARCH MODE**  
Presione este botón para localizar un punto deseado.
- 33. Botón AUDIO**  
Presione este botón para seleccionar un idioma de audio o el modo de sonido deseado.
- 34. Botón SUBTITLE**  
Presione este botón para seleccionar el idioma de subtítulos deseado.
- 35. Botón REPEAT**  
Repita la reproducción del disco, título, capítulo o pista actual.
- 36. Botón ANGLE (modo DVD)**  
Presione este botón para cambiar el ángulo de la cámara y ver la secuencia que se está reproduciendo desde un ángulo diferente.
- 37. Botón A-B REPEAT**  
Repita la reproducción de una sección seleccionada.
- 38. Botón RETURN**  
Permite volver a la operación anterior en el modo de configuración de DVD.
- 39. Botón ENTER**  
Presione este botón para establecer un ajuste.
- 40. Botones de flechas**  
**Modo TV/VCR:**  
Presione estos botones para seleccionar un modo de ajuste en el menú que aparece en la pantalla del televisor. Presiónelos también para seleccionar opciones o establecer ajustes en un menú en particular.  
**Modo DVD:**  
Use estos botones para hacer ajustes mientras observa la imagen en la pantalla del televisor.
- 41. Botón DISC MENU**  
Muestra los menús contenidos en el DVD.
- 42. Botón V.SURR**  
Activar/desactivar el envolvente virtual.
- 43. Botón MUTE**  
Suprime la salida de sonido. Presiónelo de nuevo para restablecer el sonido.
- 44. Botón SLEEP**  
Utilice este botón para ajustar el temporizador de dormir.
- 45. Botón SELECT**  
Presione este botón para cambiar entre los modos TV/VCR y DVD. El modo seleccionado (TV/VCR o DVD) se visualiza en el indicador del panel delantero.
- 46. Toma de entrada ANT.**  
Conéctela a una antena, sistema de televisión por cable o sistema de satélite.
- 47. Cable de alimentación**  
Conéctelo a una toma de CA estándar (120 V, /60 Hz).  
**NOTA:** Antes de conectar el cable de alimentación a una toma de CA estándar, retírelo del gancho para evitar dañarlo.
- 48. Toma de salida de audio digital COAXIAL**  
Conéctela solamente a la entrada digital de un amplificador externo o decodificador de audio de DVD.

## ANTENAS SEPARADAS DE VHF/UHF

En algunas zonas será necesario utilizar una antena exterior.

## TELEVISIÓN POR CABLE SIN CAJA DE CONVERTIDOR/DECODIFICADOR

Utilice esta conexión si su sistema de televisión por cable se conecta directamente a su televisor/DVD/videograbadora, sin una caja de convertidor.

Con esta conexión podrá:

- 1) Utilizar el mando a distancia del televisor/DVD/videograbadora para seleccionar canales.
- 2) Programar uno o más canales decodificados para grabación automática controlada por temporizador.

**NOTA:** Este televisor/DVD/videograbadora SÓLO puede grabar el canal que se está viendo.

## TELEVISIÓN POR CABLE CON CAJA DE CONVERTIDOR/DECODIFICADOR O CAJA DE SATELITE

Si su compañía de televisión por cable le suministra una caja de convertidor o si utiliza un sistema de satélite, podrá utilizar la conexión básica que se muestra en la ilustración.

Al utilizar esta conexión, también podrá grabar canales codificados. Sin embargo, la selección de los canales deberá hacerse con la caja de convertidor o con la caja de satélite. Esto significa que no es posible cambiar de canal utilizando el mando a distancia del televisor/DVD/videograbadora. La grabación en ausencia (controlada por temporizador) está limitada a un canal a la vez.

## PARA GRABAR UN CANAL CODIFICADO/DECODIFICADO

1. Ajuste el selector de canales del televisor/DVD/videograbadora al canal de salida de la caja de convertidor de televisión por cable o caja de satélite. (Ej., CH3)
2. Seleccione el canal que desea grabar en la caja de convertidor de televisión por cable o caja de satélite.

### Nota para el instalador de sistemas CATV

Esta nota tiene la finalidad de llamar la atención del instalador de sistemas CATV para que tenga en cuenta el Artículo 820-40 de la NEC, que proporciona recomendaciones para hacer una conexión a tierra apropiada y, en particular, especifica que la tierra del cable debe conectarse al sistema de puesta a tierra del edificio, tan cerca del punto de entrada del cable como sea posible.

## CONEXIÓN A TOMAS DE ENTRADA EXTERNA

Cuando vea un programa grabado en otra fuente (videograbadora o videocámara), utilice las tomas de entrada de audio/vídeo de la parte delantera del televisor/DVD/videograbadora.

Conecte las tomas de salida de audio/vídeo de otra fuente a las tomas AUDIO L/R y VIDEO de este televisor/DVD/videograbadora. Luego, presione los botones CHANNEL ▲/▼ hasta que aparezca "AUX" en la pantalla.

**NOTA:**

- Cuando conecte una videograbadora monofónica (otra fuente) a este televisor/DVD/videograbadora, conecte la toma de salida de audio de la videograbadora monofónica (otra fuente) a la toma AUDIO L de este televisor/DVD/videograbadora. El audio saldrá igualmente por los canales izquierdo y derecho.

## PREPARACIÓN PARA LA UTILIZACIÓN

### CONEXIONES DE ANTENA/CABLE

Consulte la figura 4 de la página 11

Consulte la figura 5 de la página 12



## PARA INSERTAR LAS PILAS

- 1) Abra la cubierta del compartimiento de las pilas empujando la cubierta del mando a distancia en el sentido de la flecha.
- 2) Inserte 2 pilas "AA" en el compartimiento de las pilas, en el sentido indicado por las marcas de polaridad (+/-).
- 3) Vuelva a poner la cubierta.

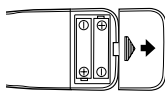

## MODO DE ENTRADA EXTERNA

Al usar una señal de entrada externa (otra videograbadora o una videocámara), conecte los cables de salida de audio/vídeo del equipo externo a las tomas AUDIO L/R IN/ VIDEO IN de su televisor/DVD/videograbadora. Luego, presione los botones CHANNEL ▲/▼ hasta que aparezca "AUX" en la pantalla.

## CONEXIÓN A UN AMPLIFICADOR ESTÉREO EQUIPADO CON TOMAS DE ENTRADA DIGITAL, PLATINA MD O PLATINA DAT (Para DVD)

Utilice un cable digital coaxial de audio de venta en el comercio especializado para hacer las conexiones de audio. Conexión a un amplificador equipado con tomas de entrada digital, platina MD o platina DAT.

Consulte la figura 6 de la página 13

### NOTAS:

- La fuente de audio de un disco grabado en formato de sonido envolvente Dolby Digital de 5,1 canales no se puede grabar como sonido digital mediante una platina MD o DAT.
- Asegúrese de desconectar la alimentación de todos los componentes del sistema antes de conectar otro componente.
- Consulte los manuales de instrucciones de los componentes que va a conectar al televisor/DVD/videograbadora.
- Ajuste la función Dolby Digital a OFF para salida de audio en el modo de configuración. La reproducción en un televisor/DVD/videograbadora utilizando ajustes incorrectos puede generar ruido y distorsión, y también puede causar daños a los altavoces.

## CONEXIÓN A UN DECODIFICADOR DOLBY DIGITAL (para DVD)

Si utiliza este televisor/DVD/videograbadora para reproducir un disco DVD grabado en formato de sonido envolvente Dolby Digital de 5,1 canales, el televisor/DVD/videograbadora emitirá un flujo de datos DOLBY DIGITAL desde su toma de salida de audio digital COAXIAL. Si conecta el reproductor a un decodificador Dolby Digital, podrá disfrutar de una tonalidad más convincente y real, con un sonido envolvente potente y de alta calidad similar al de los cines.

Utilice cables digitales coaxiales de audio disponibles en el comercio especializado para hacer las conexiones de audio.

Consulte la figura 7 de la página 14

### NOTAS:

- Asegúrese de desconectar la alimentación de todos los componentes del sistema antes de conectar otro componente.
- Consulte los manuales de instrucciones de los componentes que va a conectar al televisor/DVD/videograbadora.
- Si conecta un decodificador Dolby Digital, ajuste la función DOLBY DIGITAL a ON para salida de audio en el modo de configuración.
- A menos que se haga la conexión a un decodificador Dolby Digital, ajuste la función Dolby Digital a OFF para salida de audio en el modo de configuración. La reproducción en un televisor/DVD/videograbadora utilizando ajustes incorrectos puede generar ruido y distorsión, y también puede causar daños a los altavoces.

Fabricado bajo licencia de Dolby Laboratories. "Dolby" y el símbolo de la D doble son marcas de fábrica de Dolby Laboratories.

## SECCIÓN DE TV/VCR

## PREPARACIÓN PARA LA UTILIZACIÓN

### SELECCIÓN DE IDIOMA

TV/VCR

#### 1 Enchufe el cordón de alimentación del televisor/videograbadora

Enchufe el cordón de alimentación del televisor/videograbadora en una toma de CA estándar.

#### NOTA:

- Si aparecen algunas cifras en la esquina de la pantalla, pulse el botón POWER sin desenchufar el cordón de alimentación.

#### Asegúrese de que ...

- Pulse el botón POWER para encender el televisor/videograbadora.

NOTA: Esta función afecta sólo el idioma en el menú de la pantalla y no la fuente de audio.

#### 2 Seleccione "LANGUAGE"

Pulse el botón SETUP en el mando a distancia. Pulse el botón ▲ o ▼ para señalar "LANGUAGE".

#### 3 Seleccione "ENGLISH", "ESPAÑOL" o "FRANÇAIS"

Seleccione "ENGLISH", "ESPAÑOL" o "FRANÇAIS" con el botón ENTER.

#### 4 Salga del modo de idioma

Pulse el botón SETUP en el mando a distancia para volver al modo del televisor.

**NOTA:** Si, por alguna razón, el menú está en inglés o francés, pulse el botón SETUP en el mando a distancia, pulse el botón ▲ para señalar el “LANGUAGE [ESPAÑOL]” o “LANGAGE [FRANÇAIS]”, a continuación, pulse el botón ENTER y pulse el botón SETUP en el mando a distancia.

## AJUSTE DE CANAL

TV/VCR

Puede programar el sintonizador para buscar todos los canales que recibe en su localidad.

**NOTA:** El canal preparado NO es necesario cuando esté conectado a una caja de cable o caja de satélite. Sólo tiene que seleccionar con el selector de canal del televisor/videograbadora al canal de salida de la caja de cable o caja de satélite (por ejemplo el canal CH3). Seleccione el canal a ver en la caja de cable o caja de satélite.

### Asegúrese de que ...

- Pulse el botón POWER para encender el televisor/videograbadora.

#### 1 Seleccione “AJUSTE DE CANAL”

Pulse el botón SETUP en el mando a distancia.

Pulse el botón ▲ o ▼ para señalar “AJUSTE DE CANAL”.

A continuación, pulse el botón ENTER.

#### 2 Empiece el prefijado automático

Pulse el botón ▲ o ▼ para señalar “AUTOPROGRAMACION DE CA”.

A continuación, pulse el botón ENTER.

El sintonizador busca y memoriza todos los canales activos en su localidad.

#### 3 Después de buscar

El sintonizador se detiene en el canal memorizado más bajo.

- Cuando se activa AUTOPROGRAMACION DE CA, donde no hay entrada de señal del televisor, aparecerá “NO HAY SEÑAL DE TV” en la pantalla después de terminar la búsqueda de canales.
- El televisor/videograbadora puede reconocer los canales de TV para que sean canales de TV de antena de cable con las condiciones de recepción. En este caso, pruebe nuevamente con el prefijado automático en las condiciones de recepción fina.

## AJUSTE DEL RELOJ

TV/VCR

### Cerciórese...

- La alimentación del televisor/videograbadora deberá estar conectada.

*En el ejemplo de abajo, el reloj va a ajustarse así:*

FECHA: 6 de mayo de 2004

HORA: 5:40 PM

- 1) Pulse el botón SETUP en el mando a distancia. Pulse el botón ▲ o ▼ para indicar “AJUSTE RELOJ”.  
Luego, pulse el botón ENTER.
- 2) Pulse el botón ▲ o ▼ para indicar “AJUSTE MANUAL RELOJ”.  
Luego, pulse el botón ENTER.
- 3) Pulse el botón ▲ o ▼ hasta que aparezca el mes deseado. (Ejemplo: Mayo - 05)  
Luego, pulse el botón ►.
- 4) Pulse el botón ▲ o ▼ hasta que aparezca el día del mes deseado. (Ejemplo: 6 - 06)  
Luego, pulse el botón ►.
- 5) Pulse el botón ▲ o ▼ hasta que aparezca el año deseado. (Ejemplo: 2004)  
Luego, pulse el botón ►.
- 6) Pulse el botón ▲ o ▼ hasta que aparezca la hora deseada. (Ejemplo: 5, PM)  
Luego, pulse el botón ►.
- 7) Pulse el botón ▲ o ▼ hasta que aparezca el minuto deseado. (Ejemplo: 40)
- 8) Pulse el botón SETUP en el mando a distancia. Aunque los segundos no se visualizan, éstos empiezan a contar desde 00 cuando se pulsa SETUP en el mando a distancia. Utilice esta función para sincronizar el reloj con la hora correcta.

## SECCIÓN DE DVD

### REPRODUCCIÓN BÁSICA

DVD-V

CD

#### Para empezar

- Conecte la alimentación del amplificador y otros componentes, si es necesario.

#### 1 Presione el botón POWER.

- La alimentación se conectará.

#### 2 Presione el botón OPEN/CLOSE para abrir la bandeja de carga del disco.

#### 3 Ponga el disco deseado en la bandeja, con la etiqueta hacia arriba.

#### 4 Presione el botón PLAY.

- La bandeja se cerrará automáticamente y la reproducción comenzará desde el primer capítulo o pista del disco. Si la reproducción no comienza automáticamente, presione el botón PLAY.
- Cuando reproduzca un DVD que tenga grabado un menú de títulos, el menú podrá aparecer en la pantalla.

#### 5 Presione el botón STOP para detener la reproducción.

# **SYLVANIA**

## **LIMITED WARRANTY**

FUNAI CORP. will repair this SYLVANIA product, free of charge in the USA in the event of defect in materials or workmanship as follows:

### **DURATION:**

**PARTS:** FUNAI CORP. will provide parts to replace defective parts without charge for one (1) year from the date of original retail purchase. Two (2) years for Picture Tube. Certain parts are excluded from this warranty.

**LABOR:** FUNAI CORP. will provide the labor without charge for a period of ninety (90) days from the date of original retail purchase.

### **LIMITS AND EXCLUSIONS:**

THIS WARRANTY IS EXTENDED ONLY TO THE ORIGINAL RETAIL PURCHASER. A PURCHASE RECEIPT OR OTHER PROOF OF ORIGINAL RETAIL PURCHASE WILL BE REQUIRED TOGETHER WITH THE PRODUCT TO OBTAIN SERVICE UNDER THIS WARRANTY.

This warranty shall not be extended to any other person or transferee.

This warranty is void and of no effect if any serial numbers on the product are altered, replaced, defaced, missing or if service was attempted by an unauthorized service center. This SYLVANIA Limited warranty does not apply to any product not purchased and used in the United States.

This warranty only covers failures due to defects in material or workmanship which occurs during normal use. It does not cover damage which occurs in shipment, or failures which are caused by repairs, alterations or product not supplied by FUNAI CORP., or damage which results from accident, misuse, abuse, mishandling, misapplication, alteration, faulty installation, improper maintenance, commercial use such as hotel, rental or office use of this product or damage which results from fire, flood, lightning or other acts of God.

THIS WARRANTY DOES NOT COVER PACKING MATERIALS, ANY ACCESSORIES (EXCEPT REMOTE CONTROL), ANY COSMETIC PARTS, COMPLETE ASSEMBLY PARTS, DEMO OR FLOOR MODELS.

FUNAI CORP. AND ITS REPRESENTATIVES OR AGENTS SHALL IN NO EVENT BE LIABLE FOR ANY GENERAL, INDIRECT OR CONSEQUENTIAL DAMAGES ARISING OUT OF OR OCCASIONED BY THE USE OF OR THE INABILITY TO USE THIS PRODUCT. THIS WARRANTY IS MADE IN LIEU OF ALL OTHER WARRANTIES, EXPRESS OR IMPLIED, AND OF ALL OTHER LIABILITIES ON THE PART OF FUNAI. ALL OTHER WARRANTIES INCLUDING THE WARRANTY OF MERCHANTABILITY, AND FITNESS FOR A PARTICULAR PURPOSE, ARE HEREBY DISCLAIMED BY FUNAI AND ITS REPRESENTATIVES IN THE UNITED STATES.

ALL WARRANTY INSPECTIONS AND REPAIRS MUST BE PERFORMED BY A FUNAI AUTHORIZED SERVICE CENTER. THIS WARRANTY IS VALID WHEN THE UNIT IS CARRIED-IN TO FUNAI AUTHORIZED SERVICE FACILITY.

### **IMPORTANT:**

THIS LIMITED WARRANTY GIVES YOU SPECIFIC LEGAL RIGHTS, YOU MAY HAVE OTHER RIGHTS THAT VARY FROM STATE TO STATE, IF, AT ANY TIME DURING THE WARRANTY PERIOD, YOU ARE UNABLE TO OBTAIN SATISFACTION WITH THE REPAIR OF THIS PRODUCT, PLEASE CONTACT FUNAI CORP.

### **ATTENTION:**

FUNAI CORP. RESERVES THE RIGHT TO MODIFY ANY DESIGN OF THIS PRODUCT WITHOUT PRIOR NOTICE.

**To locate your nearest SYLVANIA Authorized Service Center or for general service procedure, please call 1-800-968-3429 or write to the following:**

**FUNAI CORPORATION, INC.  
SERVICE CENTER**

19900 Van Ness Avenue, Torrance, CA 90501

**Tel :1-800-968-3429**

**<http://www.funai-corp.com>**

Head Office: 100 North Street, Teterboro, NJ 07608

**PLEASE DO NOT SHIP YOUR UNIT TO THE TETERBORO ADDRESS.**